

Post-Processing CTscan Data with Avizo Lite 9.0.1

Patricia Wils - patricia.wils@mnhn.fr
UMS 2700 Integrative Systematics Tools and Methods



Table of contents

1	Data	3
1.1	Digital images	3
1.2	Formats	3
1.3	Data stacks	4
1.4	CTscan data.....	4
1.5	Surfaces	5
1.6	Data processing with Avizo	5
2	Starting with Avizo – The Project environment	6
2.1	Opening the data.....	7
2.2	The Properties environment	9
2.3	Software preferences	9
3	Visualizing the 3D data	10
3.1	Visualizing the slice stacks	10
3.2	The 3D visualization toolbar	11
3.3	Viewing the histogram.....	12
3.4	Adjusting the contrast.....	13
3.5	Working on a region of interest.....	14
3.5.1	Reducing the volume in a box	14
3.5.2	Subsampling the data	15
3.5.3	Viewing a section of the volume	15
3.5.4	Editing the volume manually	16
3.6	Geometric data transformation.....	17
3.7	Volume rendering.....	19
3.8	Colormap	19
4	Extracting surfaces	21
4.1	Isosurface	21
4.2	Viewing the surfaces	22
4.3	Editing the surfaces	24
4.4	Simplifying the surfaces	25
5	Segmenting the data	26
5.1	Editing the segmentation.....	26
5.2	Global thresholding	31
5.3	Generating the surfaces corresponding to the segmentation.....	32

6	Advices and tips for the segmentation.....	33
6.1	Restricting a Magic Wand tool selection	33
6.1.1	By creating a border material.....	34
6.1.2	On a slice with Draw limit line	34
6.2	Creating the surface corresponding to a specific material	34
6.3	Reducing the labels to materials of interest	36
6.4	Arithmetic and Boolean Operations on Labels	36
7	Exploiting the results.....	38
7.1	Measuring.....	38
7.2	Setting landmarks	39
7.3	Exporting snapshots.....	40
7.4	Creating a video	42
7.4.1	Slice browsing.....	42
7.4.2	Camera rotation.....	43
7.4.3	3D surface browsing	44
7.4.4	Gradual transparency	44
7.4.5	Exporting the video.....	44

1 Data

1.1 Digital images

Digital information is transformed into a simple code using 0 or 1 and is stored in a bit. To manage computer memory, eight bits are grouped in what is called an octet.

A digital image consists of pixels (picture elements) defined by their gray level. The gray level is an integer ranging from 0 to 255 if the encoding uses **8 bits** ($2^8=256$ levels) or from 0 to 65535 for an encoding of **16 bits** ($2^{16}=65536$ levels).

The size of an image is determined by its number of pixels and the encoding value. An image of 16x10 pixels encoded in 8 bits will have a size of $16 \times 10 \times 8 = 1,280$ bits or $16 \times 10 = 160$ octets. The same image encoded in 16 bits will have a size of $16 \times 10 \times 16 = 2,560$ bits or $16 \times 10 \times 2 = 320$ octets. Figure 1 shows an image of 16x10 pixels.

The **dynamic range** of an image is the range of gray levels used. Therefore, a 16-bit image has a much higher dynamic range than an 8-bit image. The greater the dynamic range, the more visible the details and the sharper the edges.

251	245	236	223	208	191	173	153
245	240	230	218	203	187	169	150
236	230	222	210	196	179	162	144
223	218	210	199	185	170	153	136
208	203	196	185	173	158	143	127
191	187	179	170	158	145	131	117
173	169	162	153	143	131	119	105
153	150	144	136	127	117	105	94
134	131	126	120	111	102	92	82
116	113	109	103	96	88	80	71
64507	62965	60652	57311	53456	49087	44461	39321
62965	61680	59110	56026	52171	48059	43433	38550
60652	59110	57054	53970	50372	46003	41634	37008
57311	56026	53970	51143	47545	43690	39321	34952
53456	52171	50372	47545	44461	40606	36751	32639
49087	48059	46003	43690	40606	37265	33667	30069
44461	43433	41634	39321	36751	33667	30583	26985
39321	38550	37008	34952	32639	30069	26985	24158
34438	33667	32382	30840	28527	26214	23644	21074
29812	29041	28013	26471	24672	22616	20560	18247

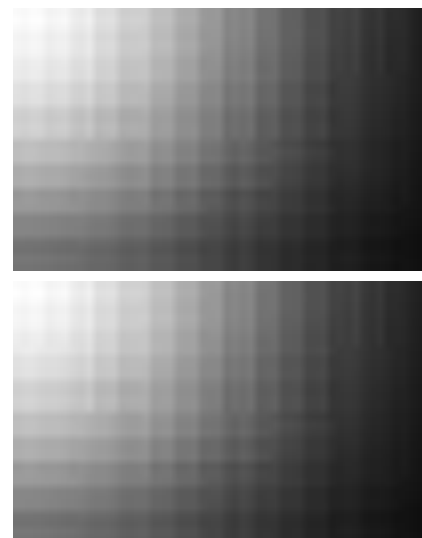

Figure 1 – Example of an image encoded in 8 bits and in 16 bits.

1.2 Formats

The digital data that form an image can be stored in different ways depending on the file format.

- JPEG. Images are compressed using an algorithm that removes the details. The resulting images use less memory space. However, the compression leads to a loss of information and this format is not appropriate for advanced studies.
- PNG. Images are compressed using a non-destructive algorithm. Data reduction is lower than with the JPEG format as the data remain untouched. This format is adequate for online data exchange or for reports and presentations.
- BMP. Images are coded with a matrix code for each pixel. This format contains a maximum of information and uses huge memory space. It is rare in 16 bits. A compression algorithm supports work with 8-bit images.
- DICOM. This format is used in the medical field. The header stores the information on scanners and protocols, which is convenient because these information do not have to be stored in a separate text file.
- TIF. This format is particularly appropriate for the quantitative analysis of data as it allows access to the maximum amount of information. Images are described as a matrix and the compression can be non-destructive. The management of data stacks is possible and is particularly useful for processing CT-scan data.

1.3 Data stacks

The scanner exports a 3D image, which is a set of 2D image slices of the volume of the tomography-scanned object, extracted along a direction, for instance through the xy plane shown in Figure 2. Stack representation is the simplest way to visualize and to process the data. The first image corresponds to the horizontal slice for $z=0$ and the subsequent images are the subsequent slices along the z axis.

The volume is thus described as a 3D matrix of isometric voxels. It is always possible to describe the object along other slice planes. The dimensions of the exported volume are indicated in the text file attached to the data. Open the file with a text editor such as Notepad. [The information is provided in the \[Geometry\] section by VoxelSizeX and VoxelSizeY in mm. The Z dimension is the same because the voxels are cubic.](#)

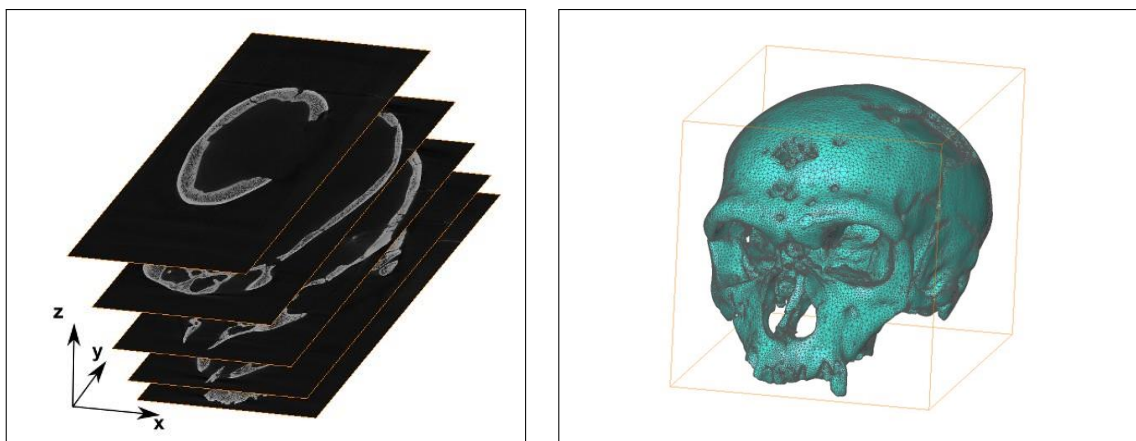

Figure 2 – Left: Description of the object volume with a 3D image, the slice stack. The slices here are on the xy plane. Right: A 3D surface representing the skull.

1.4 CTscan data

The image stack provides a description in gray levels of the scanned image as 16-bit images. Voxel values range from 0 to 65,535. These values correspond to an attenuation code for each voxel. The x-ray attenuation is proportional to the **density** of the materials. The lowest values represent the areas of the scan with the lowest density (typically air) and the highest values those with the highest density (tissue, then bone, sediment, enamel).

Data from medical scans are often exported in 11 or 12 bits and the values of each pixel are encoded between -1024 and 1024 or between 0 and 4096 respectively. The attenuation values are expressed in Hounsfield units (HU) and calibrated with reference to water attenuation on the Hounsfield scale.

The ImageJ software provides a wide range of tools for data preparation. See the document on post-processing CT-scan data with ImageJ/Fiji.

1.5 Surfaces

A 3D surface is made of a series of points, usually connected by triangles as seen in Figure 2. Image processing is performed by generating and isolating 3D surfaces corresponding to structures in the 3D image, using isosurfaces (see Section 4) or data segmentation (see Section 5).

The Avizo format uses a .surf extension. However, it is preferable to save the surfaces under another format to be able to process them with other software programs. Meshlab is a free software for surface reprocessing. The STL format is the most common but the PLY format is preferable for morphometric analyses. The OBJ format saves the color information associated with each triangle.

1.6 Data processing with Avizo

The main use of the Avizo software is the modelling of 3D surfaces from the 3D image obtained from the CTscan.

This document presents the various steps to produce the 3D models.

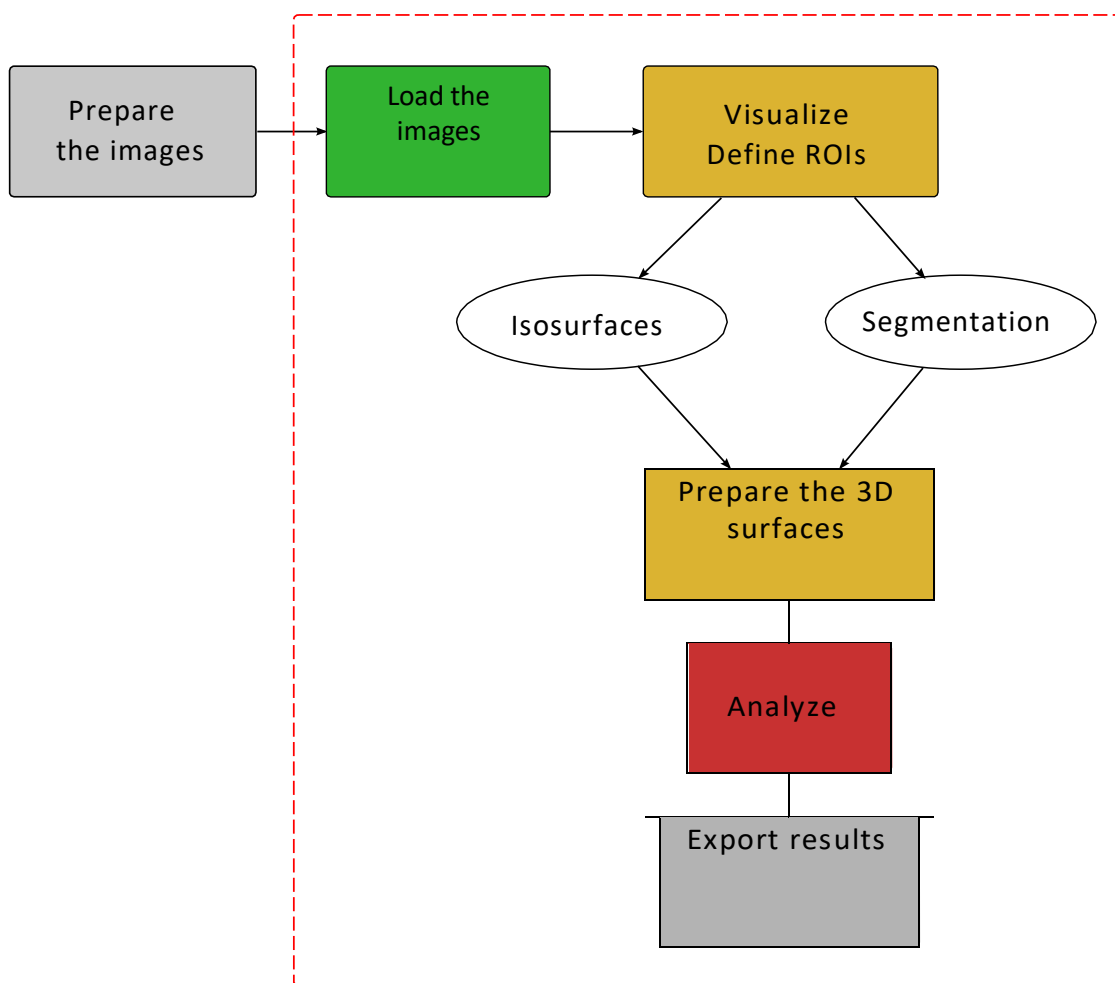

Figure 3 – The data processing protocol.

2 Starting with Avizo – The Project environment

Figure 4 shows the software home page.

The **Open Data** and **Open Project** buttons provide quick access to previously saved projects.

To start a new project, select **Blank project**.

The Start, Project, Segmentation, and Animation tabs facilitate the navigation between the environments described throughout this document.

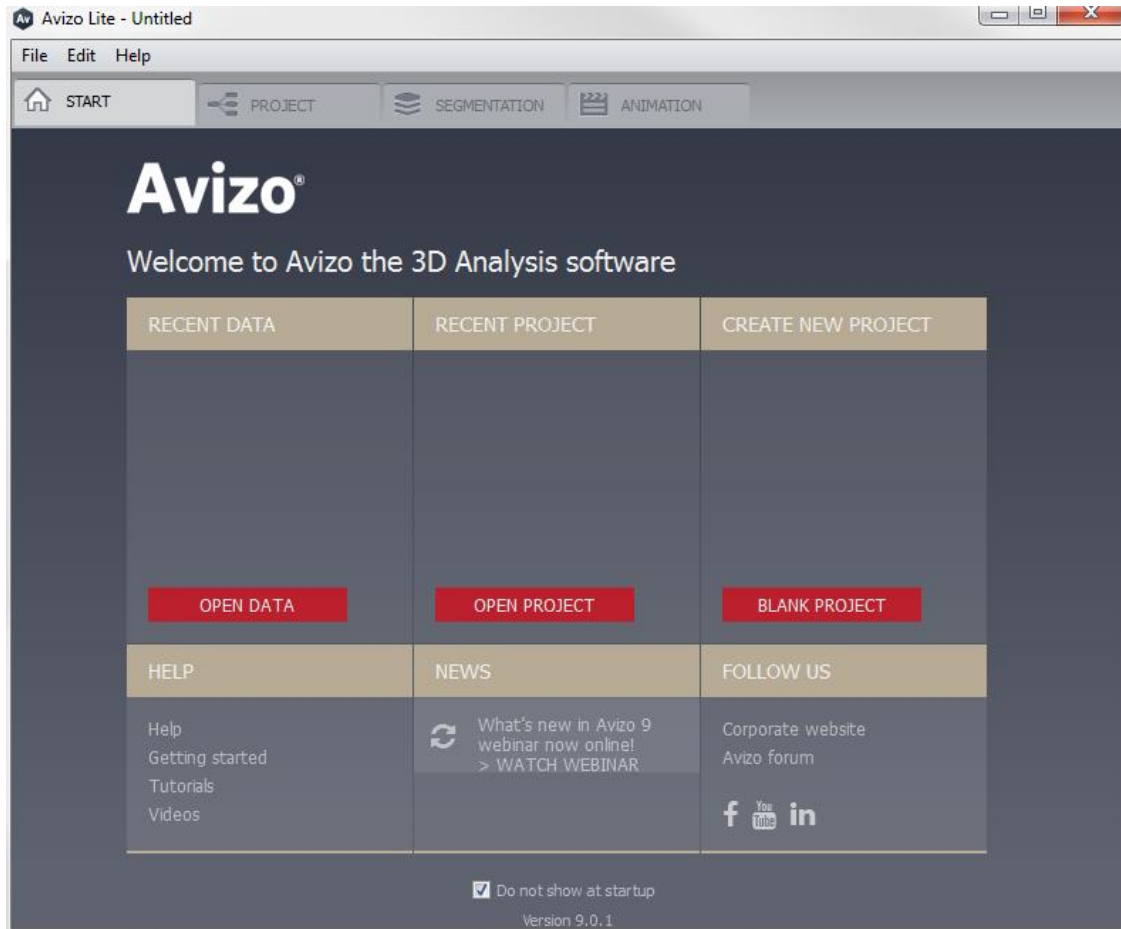

Figure 4 – General overview when starting the Avizo Lite 9.0.1 software.

The Project environment has several components: a 3D visualization window and its toolbar (1), a Project View window (2), and a Properties window (3), see Figure 5.

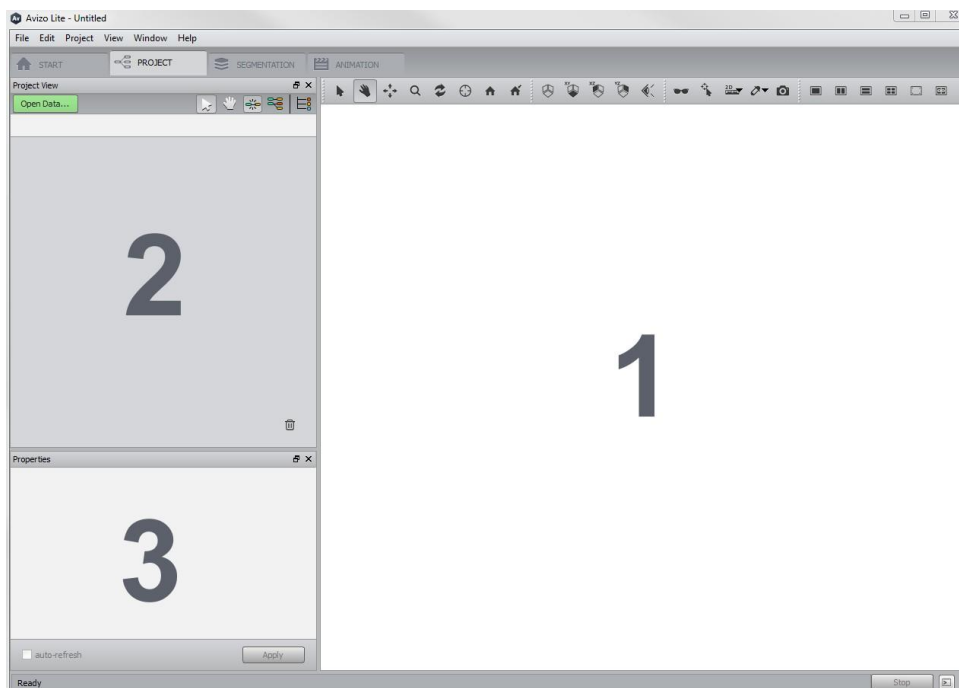

Figure 5 – General overview of the Project environment

2.1 Opening the data

To start the process, click on **Open Data**. Select the slice set and click on open. The Image Read Parameters window (Figure 6) allows the user to verify if the number of selected slices is correct. In this example, the data set has 1,318 slices of 1209x1215 pixels.

The object name bears the name of the first slice, but it should be edited with an explicit name. [Enter the voxel size \(in mm\) under voxel size. This calibration is essential for the measurements to be accurate.](#) For data obtained from AST-RX, this information can be found in the text file provided with the images under the name voxelsizex.

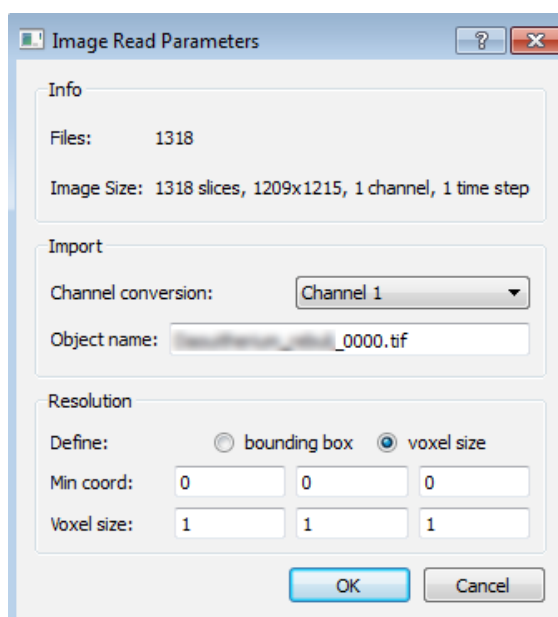

Figure 6 – Data opening window.

The created object appears in the Project View window as a green module. The most common commands appear as shortcuts in the yellow modules (Figure 7).

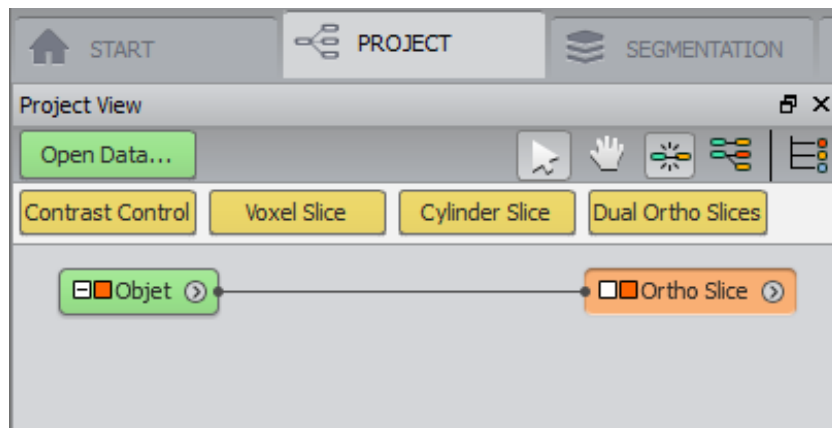

Figure 7 –Project View Tab in the Main Panel and modules for a 3D image (in green) and its visualization in Ortho Slice (in orange).

The orange square at the left of an object activates or deactivates its visualization in the 3D viewer window.

The set of commands available for a given object is accessible by **right-clicking on the object**.

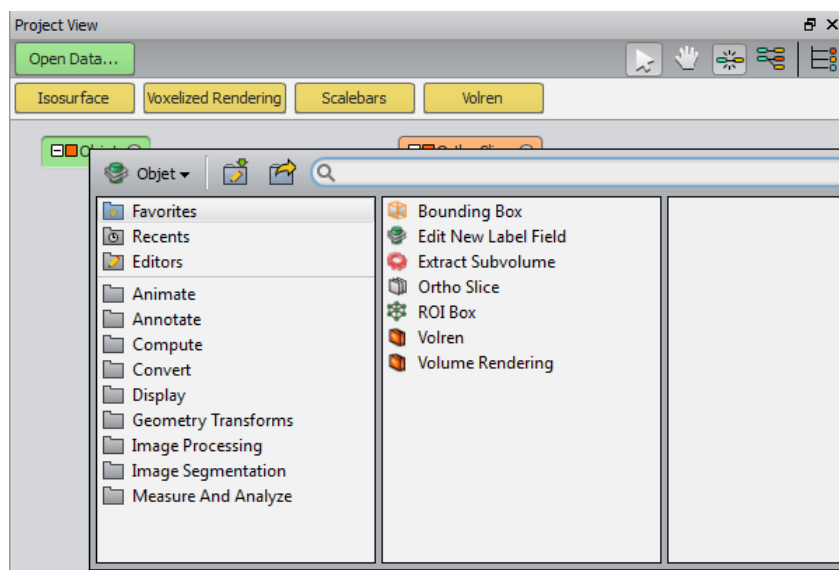

Figure 8 – Access to commands by right-clicking on the data green module.

The search bar is used to find a command using its name. All the commands are filed in the left column menu (Figure 8). The most common commands are found in the central column.

In this window, the **Save Data as** file icon is used to save the object created from the slices under the Avizo format (with the .am extension) to access the project easily for subsequent processing. The 9.0.1 version of Avizo opens volumes generated under previous versions. However, work should be saved under the Avizo 6 format to use data from versions anterior to Avizo 7.

The **Export Data as** file icon provides access to a large number of 3D data formats.

2.2 The Properties environment

When clicking on an object, its characteristics appear in the Properties tab (Figure 9). Shortcuts to certain tools are available. For the 3D image, the Properties tab provides access to cropping (Crop Editor) or geometric transformation tools (Transform Editor).



Figure 9 – Properties tab for a 3D image.

2.3 Software preferences

The global parameters of the software are accessible in the **Edit/Preferences** menu.

In particular, make sure to define the Out-of-Core limit in the LDA tab (Figure 10) that sets the maximum RAM allocated to Avizo to open the data.

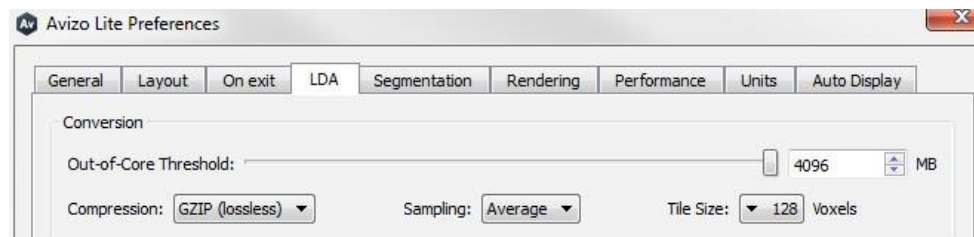

Figure 10 – Limit of available RAM.

A new feature of version 9 enables the user to set an automatic display of the associated modules when opening the data (Figure 11). In practice, the Ortho Slice and Bounding Box modules are almost always systematically associated with a 3D image and the Surface View module with a 3D surface.

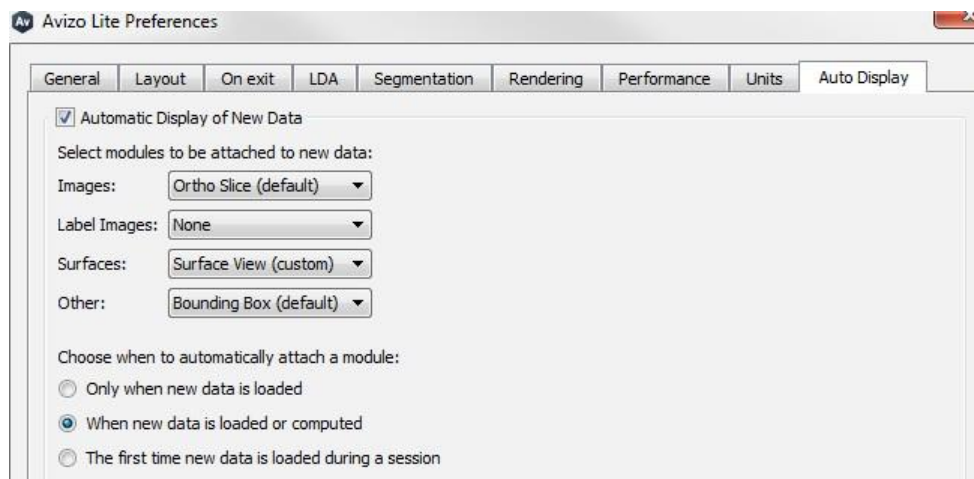

Figure 11 – Preferences for the automatic creation of visualization modules.

3 Visualizing the 3D data

3.1 Visualizing the slice stacks

The **Bounding Box** tool displays the object's bounding box (in orange) and enables the navigation in the volume.

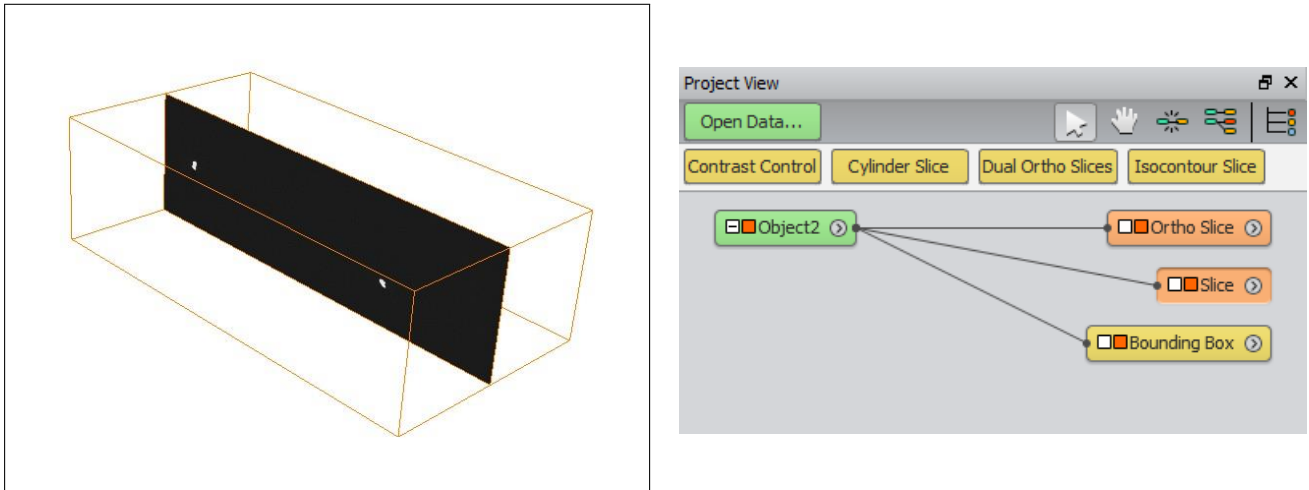

Figure 12 – Slice visualization with the Bounding Box, Ortho Slice and Slice tools.

The **Ortho Slice** tool enables the navigation in the slices by moving the **Slice Number** cursor. Modify the direction of the slices (xy, xz or yz) to visualize the slices along another axis.

Adjust the image contrast with the Min and Max cursors of **Colormap**, see Section 3.4.

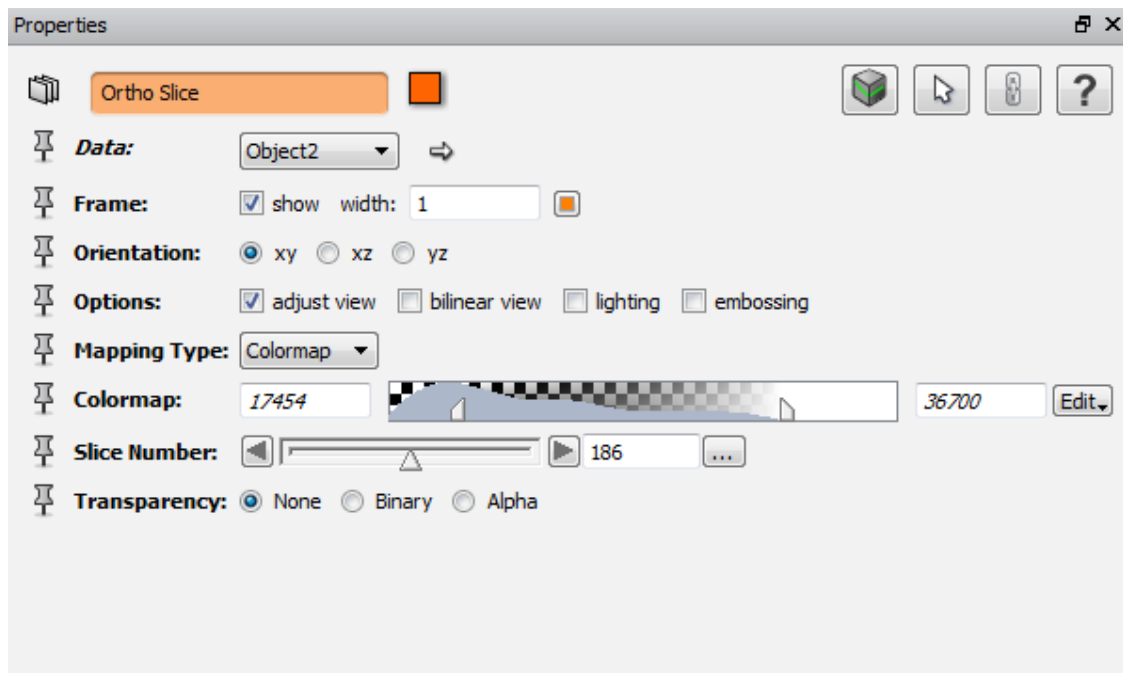

Figure 13 –Ortho Slice tool for navigating the slices.

To select the slice plane for the volume, use the **Display/Slice** tool. By default, Slice acts like Ortho Slice. However, by checking the **Rotate** option, a trackball appears in the 3D window. This trackball can be manipulated (using the arrow, Figure 15) to move the slice plane along any direction (Figure 14). The **Fit to points** option allows the user to select three points in the 3D visualization and to extract the corresponding slice plane. By default, this volume is sampled by the Slice tool. To avoid information loss, select the **finest** option in the **Sampling** field.

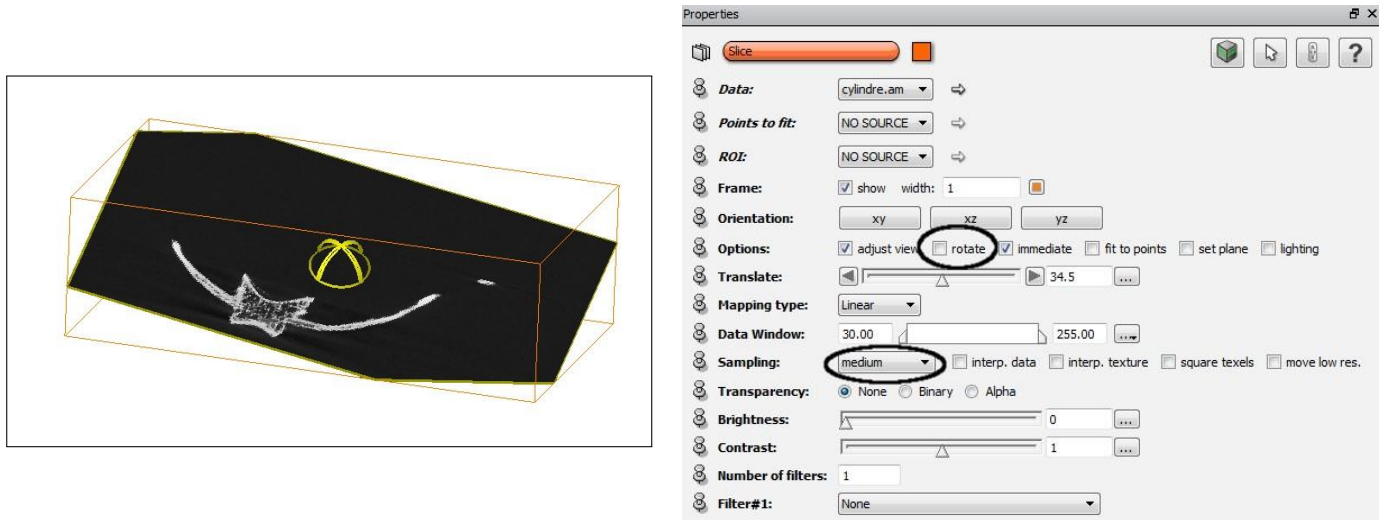

Figure 14 –Slice tool to navigate in the slices with the Rotate option.

3.2 The 3D viewer toolbar

The first toolbar (Figure 15) is used for interaction with the volume.



Figure 15

The **Interact** environment (the arrow) enables the selection of or interaction with elements in the 3D viewer. The other environment, **Trackball** (the hand), is used to modify the object view:

- Performing a free rotation with the left click or a one degree-rotation with the **Rotate** tool
- Moving by holding down the middle mouse button or with the **Translate** tool
- Zooming using the scroll wheel or with the **Zoom** tool
- Self-centering with the **Seek** tool
- Returning to the initial view with the **Home** tool
- Setting the current view as the new reference view with the **Set home** tool



Figure 16

The second module allows the user to realign the view along a given plane (xy, xz, or yz). The opposite view is accessible by holding the shift button down. Shift from a perspective view or an orthographic view with the **Perspective** tool (the eye). [Keep the orthographic view to avoid object distortion and to set a scale in a 3D view.](#)



Figure 17

The third module provides a **Stereo** tool to adjust the stereovision. The **Measurement** tool enables several types of measurements (see Section 7.1). The **Probe** tool provides interactive information (position, gray level) on an image in the 3D view. Finally, the **Snapshot** tool exports an image from the main window (see Section 7.3).



Figure 18

The last module modifies the number of visible windows in the main window and allows the user to shift to full screen (F11 key).

3.3 Viewing the histogram

The **Measure/Histogram** tool displays the histogram of the image stack, see Figure 19. This graph represents the pixel distribution according to their gray level.

Therefore, pixels with low gray levels (representing air) are on the left of the histogram. They are generally found in great number in the 3D image and appear as a peak on the histogram (except if the scan is performed on a region of interest in the object).

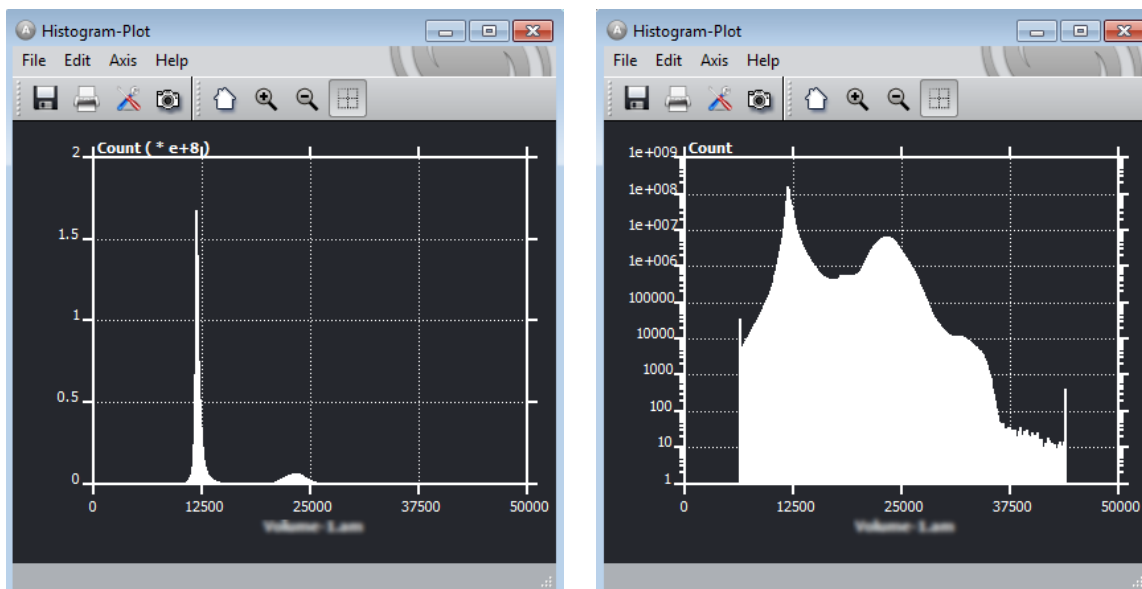

Figure 19 – Linear (left) and logarithmic (right) representation of the image histogram.

The analysis of the histogram reveals the gray levels pertaining to the object information. The different types of information are visualized by peaks or humps in the gray level distribution.

Therefore, the histogram identifies the borders between the different materials of the scanned object, expressed in levels of gray. These borders are called **thresholds** and are used for object discrimination.

In the case illustrated in Figure 19, only the pixels with a gray level higher than approximately 17,500 belong to the object. Those with a lower gray level represent air.

To refine the analysis of the histogram, some parameters are available in the Properties window (Figure 20). The minimum and maximum gray levels of the image are specified in the **Range** field. Keep these values to get the complete histogram or modify them to trace the histogram of a gray level range. The **Num bins** cursor defines the discretization of the histogram; select 256 to smooth the curve. By default, the graph is represented in columns; select **line drawing** for better readability. It also uses a semi-logarithmic scale; deselect **logarithmic** for linear representation.

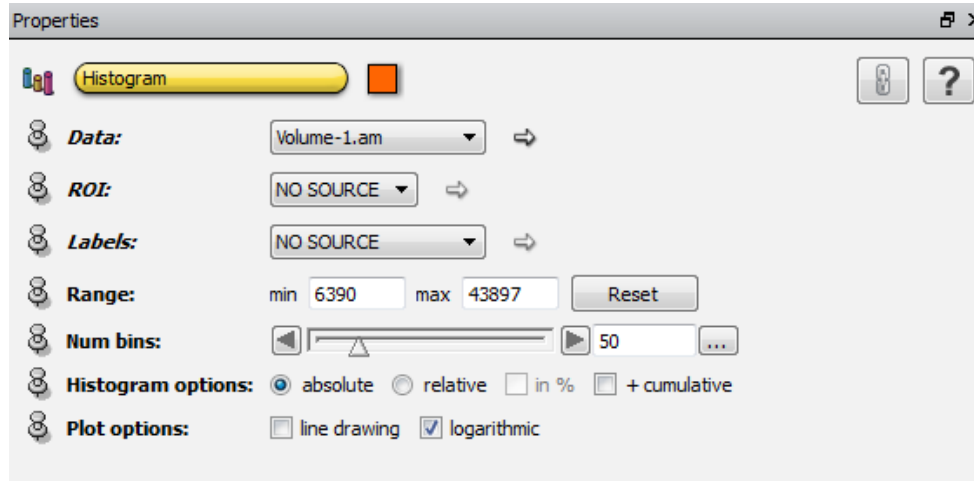

Figure 20 –Histogram tool in the Measure menu.

To browse the graph, select the **Threshold** tool in the **Edit/Edit objects** menu of the histogram. Tick the **Probe** box. A line appears on the histogram and the coordinates are displayed on the graph.

3.4 Adjusting the contrast

To improve the image contrast, the software provides a window with the gray level histogram and two values to set: the Min threshold and the Max threshold.

It is possible to display only some of the gray levels of the image, those describing the object. Pixels with gray levels that are lower than the Min value (left cursor) are represented in black and pixels with gray levels higher than the Max value (right cursor) are in white.

In general, the lower threshold is selected to avoid displaying the pixels that represent air, bearing the lowest gray level and corresponding to the left peak of the histogram (Figure 21).

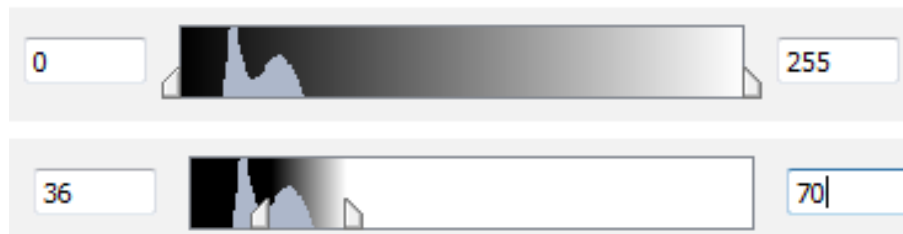

Figure 21 – Adjusting the view contrast by thresholding the histogram.

Contrast setting only modifies the visualization of the images; the pixel values remain the same. Contrast setting helps to improve image readability, to discern the details, and to rest the eyes of the user. It is crucial to adjust the contrast correctly when opening the data.

3.5 Working on a region of interest

The 3D images obtained by microtomography are generally matrices with sides of over a thousand pixels. The analysis of each pixel slows down the processing and the software might struggle to perform some calculations. To accelerate the process, it is worth restricting the processing to regions of interest. There are several strategies to do so.

3.5.1 Reducing the volume in a box

Select the **Extract Subvolume** tool in the object menu. This allows the user to define a new region to cut (Figure 22). The new region is a rectangle defined by a min index and a size for each direction. They can be defined manually on the blue squares inside the image, using the **Interact** tool (the arrow on the toolbar, Figure 15). It is easier to first click on each of the max to obtain the maximum size box, then reduce it.

The action of the tool is illustrated in Figure 22. The new object is a set of slices, the dimension of which correspond to the box. By default, the new object receives the name of the originating volume, followed by the extension .view.

Beware of the **Subsample** option that subsamples the data and modifies the resolution of the slices. To keep the best description of the volume, uncheck the **Subsample** box.

On the other hand, it might be useful to work on a lower resolution version of the image when the image is too big and impedes the calculations. To do so, enter an identical subsampling factor for each direction.

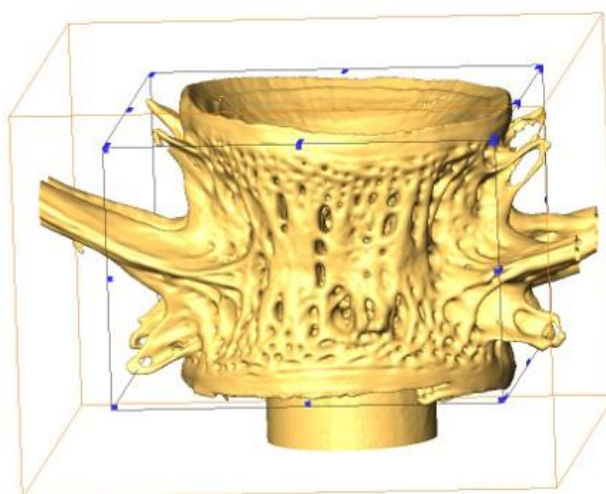
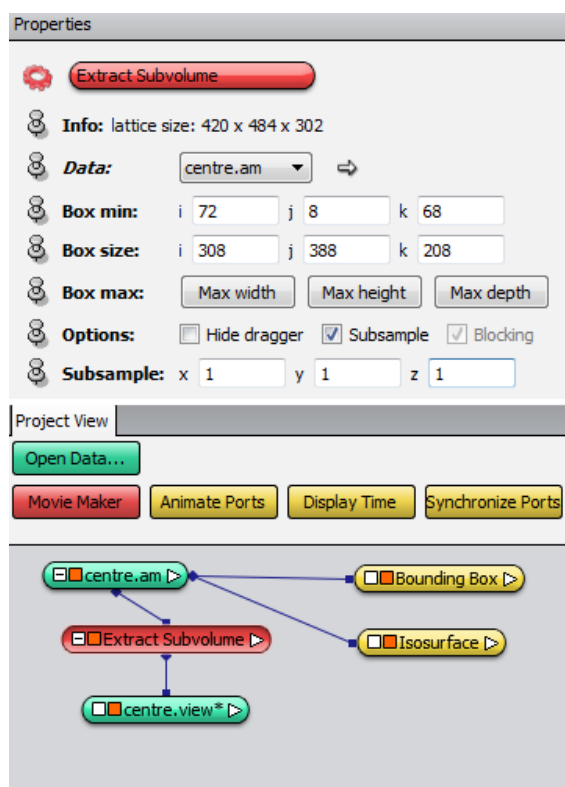

Figure 22 – Creation of a new volume of interest and data extraction with the Extract Subvolume tool.

The geometric position of the created subvolumes is saved.

3.5.2 Subsampling the data

The **Resample** tool sub-samples the set of data. A reduction factor is applied; select the same one for each direction to avoid any distortion.

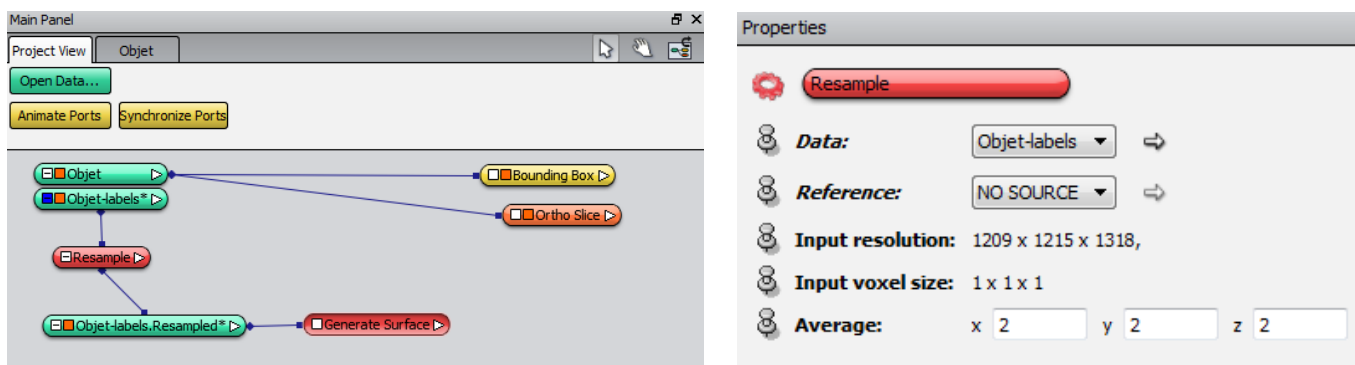

Figure 23 – Subsampling the labels with the Resample tool.

For example, a 3D image of 1200x1000x800 voxels and side of 0.15mm, sub-sampled by a factor of 2x2x2 creates a new 3D image of 600x500x400 voxels and a side of 0.3mm. Each new voxel is obtained by averaging the pixels of the original image. The scan quality is lower, but the image produced is lighter. Be careful to save the new dataset under a new name to avoid overwriting the original data.

3.5.3 Viewing a section of the volume

The **ROIbox** tool defines a region of interest as a box defined by minimum and maximum coordinates. The box edges can be defined interactively on the green cubes in the 3D viewer window using the **Interact** tool (the arrow on the toolbar, Figure 15).

The created region is not physically described by new images as in the case of the **Extract Subvolume** tool but it will be a parameter for the **VolumeRendering** (Figure 31) or **Isosurface** visualization tools (Figure 33).

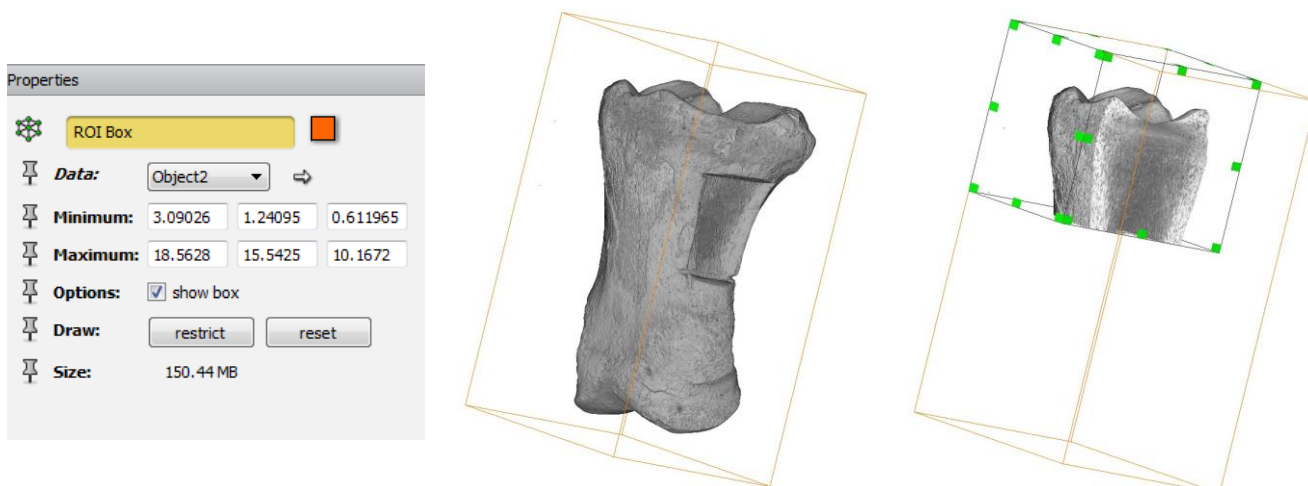

Figure 24 – Creation of a box of interest RoiBox to limit the process to a section of the 3D image.

ROIbox significantly reduces the calculation times by displaying only a section of the volume.

3.5.4 Editing the volume manually

It is possible to exclude a section of the object by interacting directly with the 3D view. To do so, use the **Compute/Volume Operations/Volume Edit** tool (Figure 25).

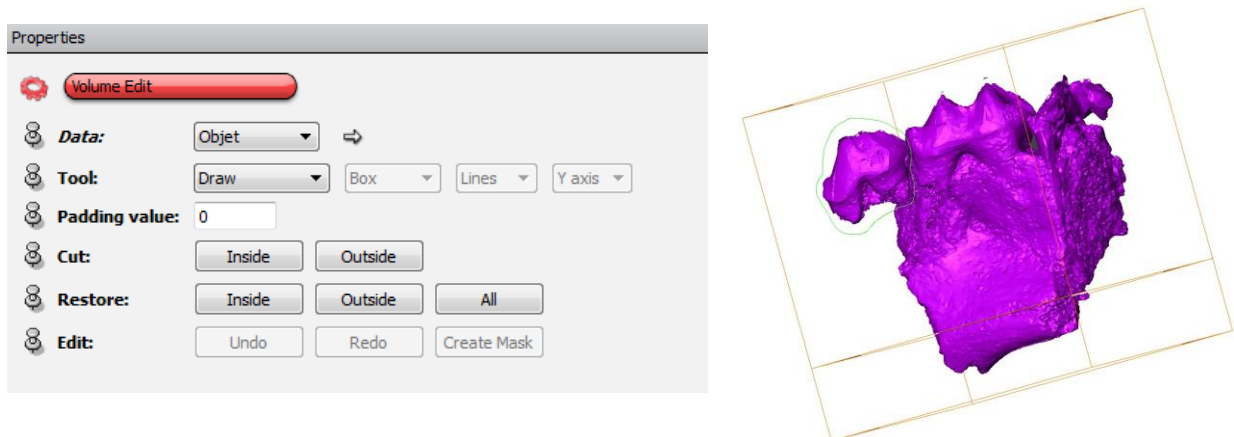

Figure 25 –Volume Edit tool (left) and selection of the region (in green) by drawing on the 3D view (right).

In the 3D view, manipulate the object (rotation, translation, zoom) to clearly distinguish the section of the volume to be isolated. While working from the slices is possible, this step is easier with a surface model of the object. To obtain this model, build an isosurface (see Section 4). There are two possible applications:

- Click on **Inside** in the **Cut** menu to draw a region to be extracted from the volume.
- Click on **Outside** in the **Cut** menu to draw the region to be kept.

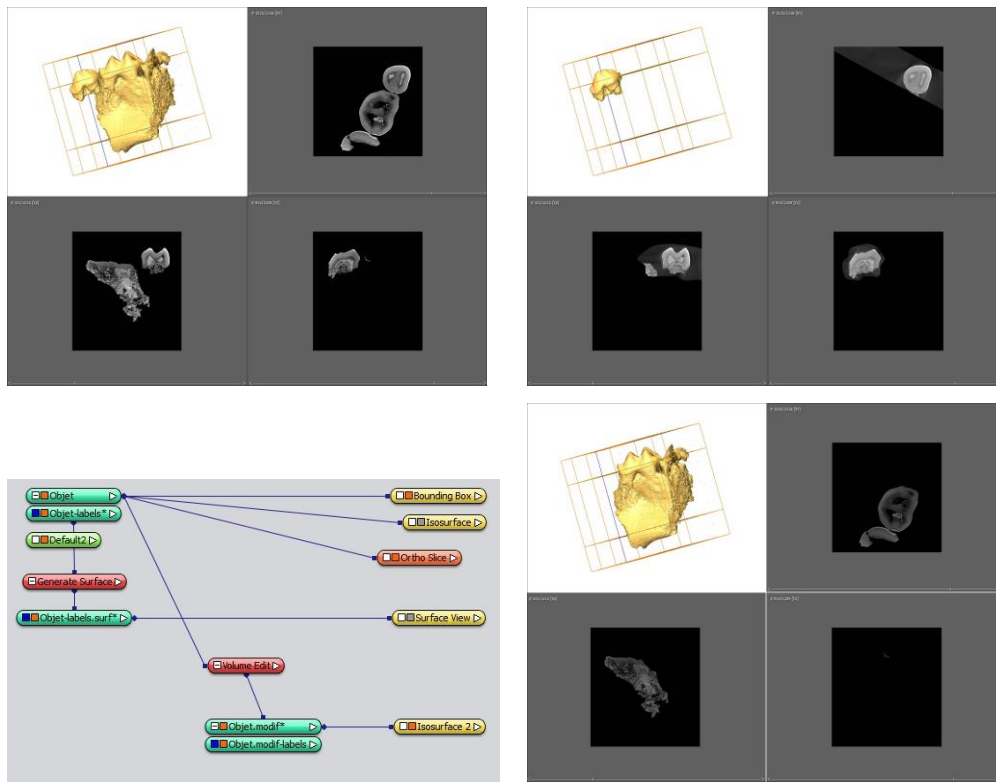

Figure 26 – Slices and isosurfaces illustrating the Volume Edit action. Initial volume (top left) and modified volume by keeping the region of Figure 25 with Cut Outside (top right) or by excluding it with Cut Inside (bottom right). The result of Volume Edit is a new 3D image.

A new image stack is created. Pixels that are not included in the kept region are allocated the value of the **Padding value** field. As a general rule, this value should be set to zero or allocated the air value. The new object is named after the original object followed by the extension .modif.

Figure 26 shows how to isolate a section of the surface. The new object is made out of slices for which only the kept region has the gray levels of the original image. It is possible to work on and segment this new object in the same way as the original object. Save these new data under the project format .am to facilitate the work on the data section of interest.

3.6 Geometric data transformation

Under the project proprieties, select the **Transform Editor** tool (Figure 27). To configure the transformation, click on the **Dialog...** button in the **Manipulator** menu. A window titled **Transform Editor** allows the user to set the parameters of the targeted transformation.

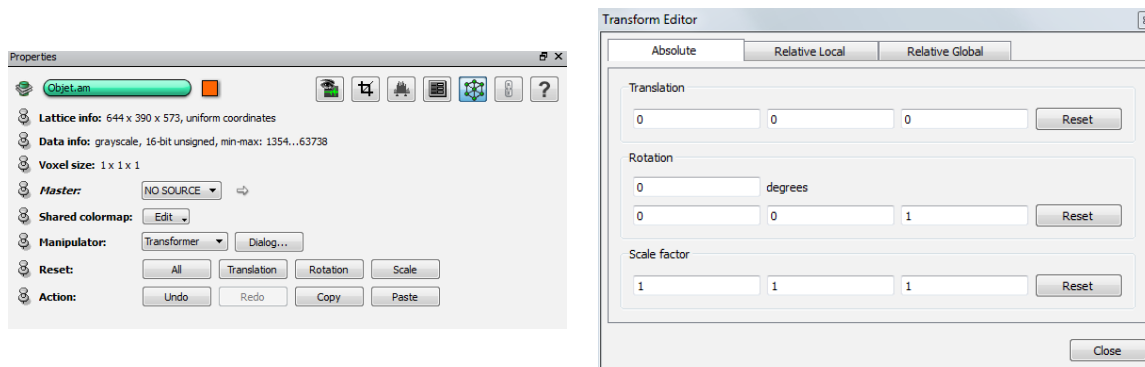

Figure 27 – Image transformation tool

It is also possible to perform a translation, a rotation or a magnification by direct manipulation in the main view using the **Interact** tool (the arrow of Module 15), as shown in Figure 28.

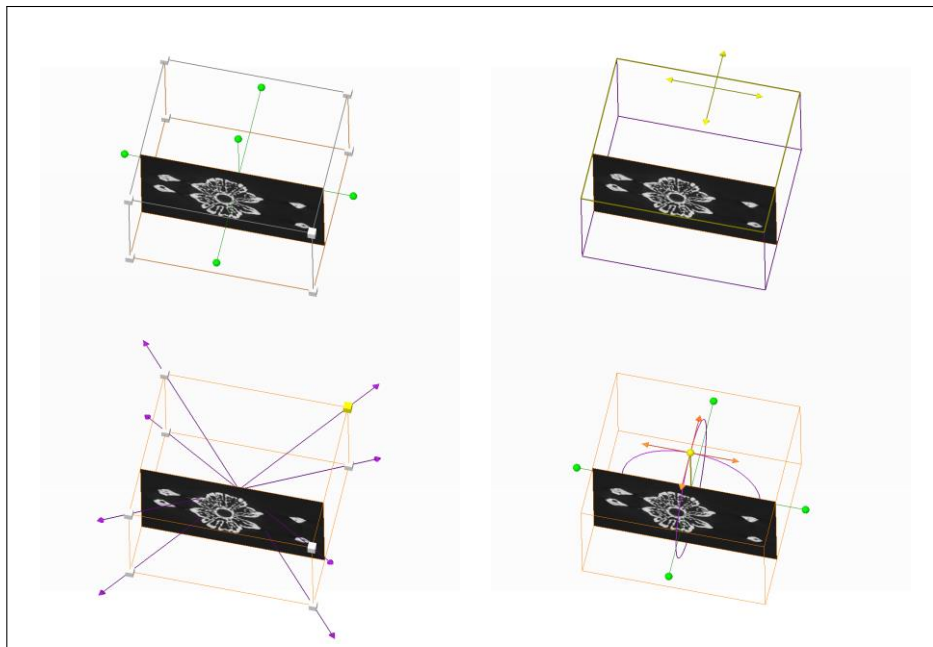

Figure 28 – The Transform tool provides a set of manipulable points (top left). Translation (top right) by working on the green points. Magnification (bottom left) by working on the white squares. Rotation by working on the green point in the center.

To modify the axes, select the **Crop Editor** tool under the object properties (Figure 9).

The **Flip and swap** menu offers the possibility to perform rotations along axes (in particular to create a symmetrical or mirror image of the original data).

In addition, this tool enables a posteriori setting of the voxel size if it was not correctly entered when the data were first opened.

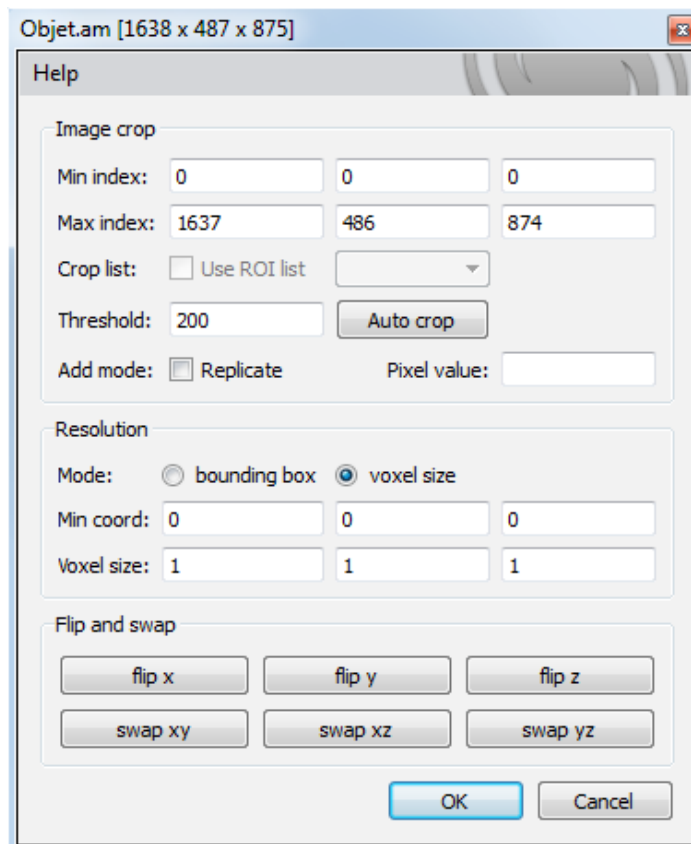

Figure 29 – Crop Editor tool to crop, to modify the resolution, and to modify the axes.

The transformed volume is indicated in italics in the Project View window.
When saving the data, the transformation might not be included.
Take note of the different transformations to be able to find them when reopening the software.

3.7 Volume rendering

Direct volume rendering is based on the ray-tracing algorithm. The voxelized object is represented in an environment by a camera and a projection screen (Figure 30). Each voxel is converted from gray levels to opacity. A ray is traced from the camera to each pixel on the screen. Its path goes through the voxelized volume and the opacity data along the ray is cumulated then deposited in the corresponding screen pixel.

This method enables the visualization of the volume from the point of view of the camera. Volume rendering is generally improved by adjusting the light sources in the previously constructed environment.

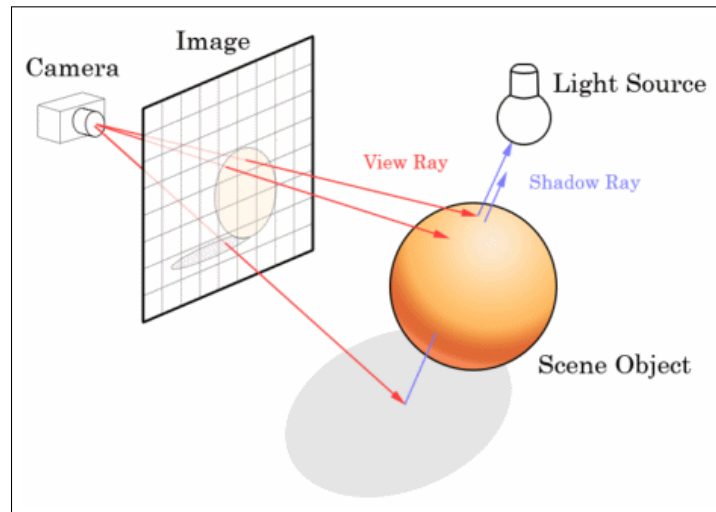

Figure 30 – Direct volume rendering. Principle of the ray-tracing algorithm. (Illustration by Jeff Atwood)

The **Display/Volume Rendering** tool allows the user to build the volume rendering of the object. It has two components:

- **Volume Rendering** controls the conversion step of gray levels through Colormap (see Section 3.8). By default, all of the gray levels are converted into transparency. The gray level range can be reduced by inserting new minimum and maximum values (Figure 31). Use the histogram to find the minimum and maximum values that allow the best description of the object (see Section 3.3).
- **Volume Rendering Settings** allows the user to improve the quality of the rendering, to modify the lighting of the scene, and to increase the description of the object contours.

3.8 Colormap

Colormap enables the allocation of a color to each voxel according to its gray level. It is based on the default image values. As a first step, the minimum and maximum values to be visualized must be selected (circled in red in Figure 31). The **Edit** tab enables the modification of the colors used by loading a .col file. Other colormaps are available in Avizo and accessible through the **Edit/Options/Load colormap...** menu. The **Alpha scale** cursor manages the transparency of the rendering.

To create a custom colormap, use the **Create/Data/Colormap** tool. Fill the **Data field** to link the colormap to a dataset. Under the colormap properties, the **Colormap Editor** tool enables the setting of a new coloring function.

From the colormap object, create a **Colormap Legend** object to add the scale to the image (Figure 31).

Specify the min and max limits in the Colormap object.

Several options are available to edit the legend:

- Data: The type of colormap used
- Options: **custom text** edits the legend, **vertical** modifies the direction, **font** manages the font type and **bg color** the background color
- Position: places the scale on the image
- Size: manages the size
- Custom Text: modifies the legend, keep the / to separate the displayed values
- Title: adds a title

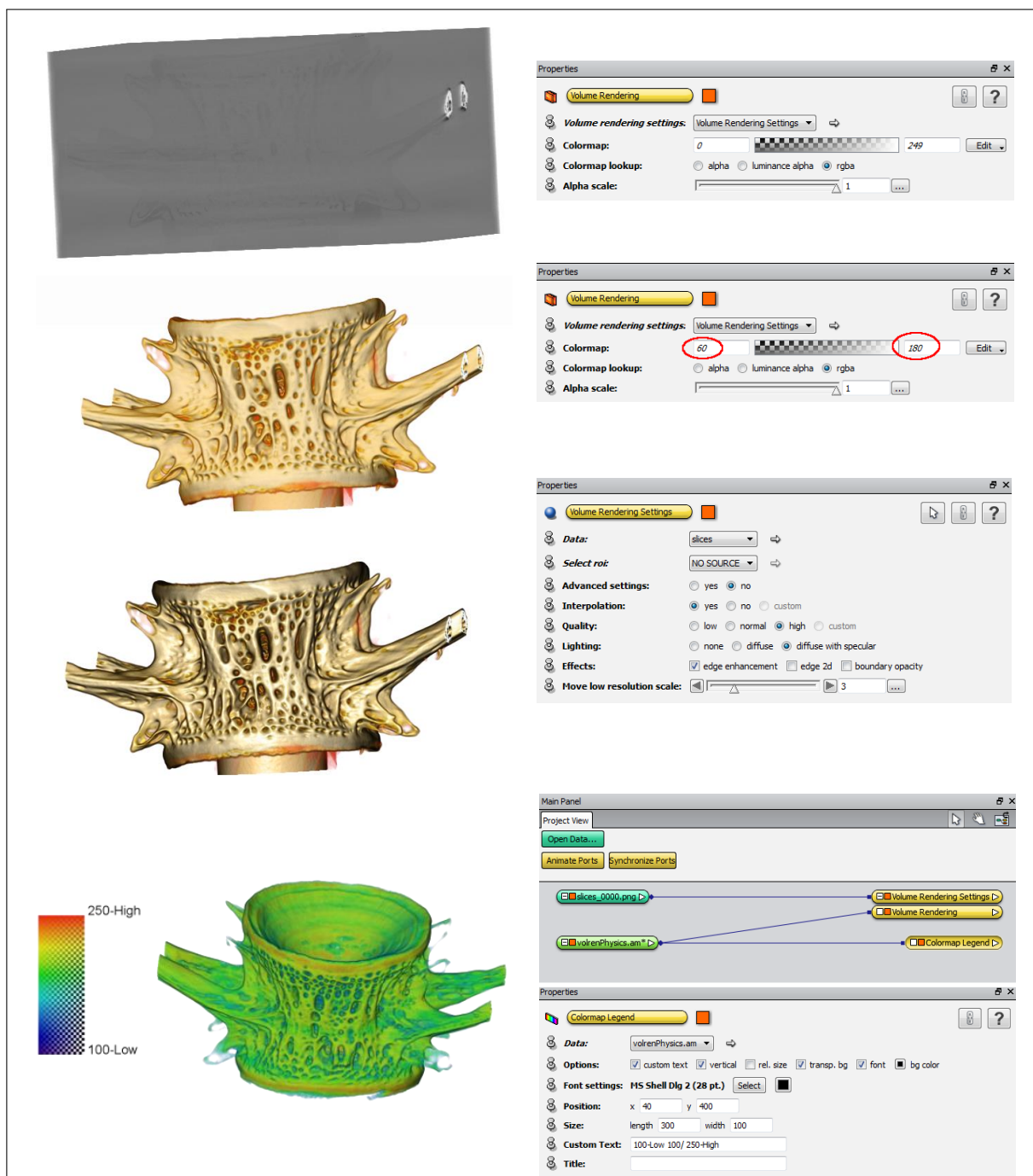

Figure 31 – Visualization of the volume with Volume Rendering. Rendering by default (top) with modification of the colormap in volrenRed.col (middle) and with lighting modification and enhancement of the contour rendering (bottom). Creation of a colormap and the associated legend for volume rendering.

4 Extracting surfaces

4.1 Isosurface

The **Display/Isosurface** tool builds the surface bounding the sections of the volume for which the gray level is higher than the given threshold. It is the equivalent of an isocontour in three dimensions. Therefore, the isosurface is the fastest tool to **visualize** the external shape of an object or the contours of a structure. Figure 32 illustrates the principle for building isosurfaces with the synthetic case of a cylinder containing two other cylinders with lower gray levels.

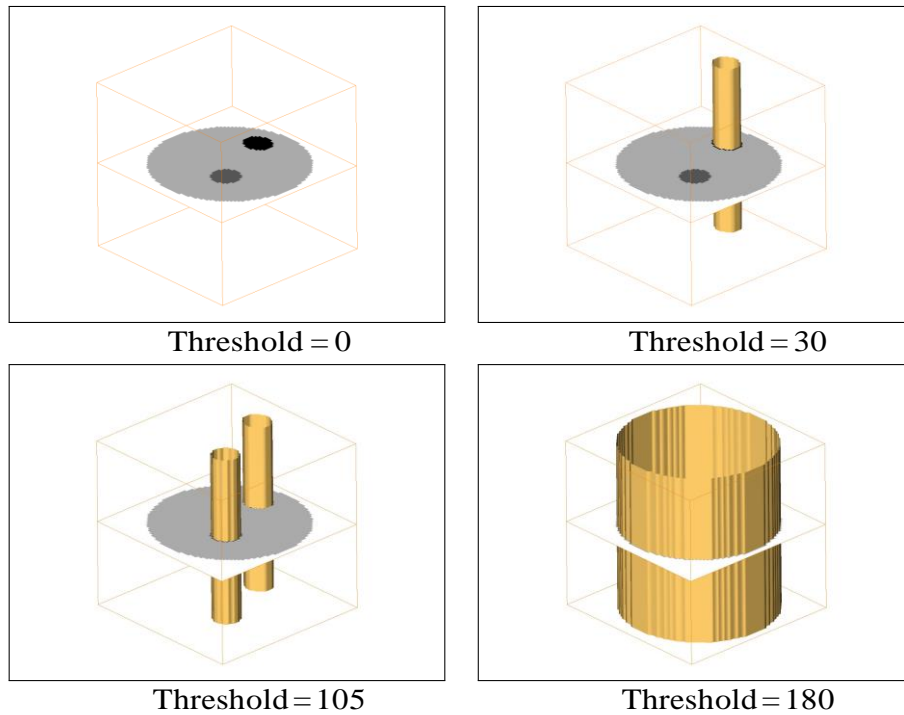

Figure 32 – Example of isosurfaces created on a model. The gray levels of the cylinders are 180 for the large cylinder and 30 and 105 respectively for the small ones. The threshold value used for the isosurfaces is indicated below each figure.

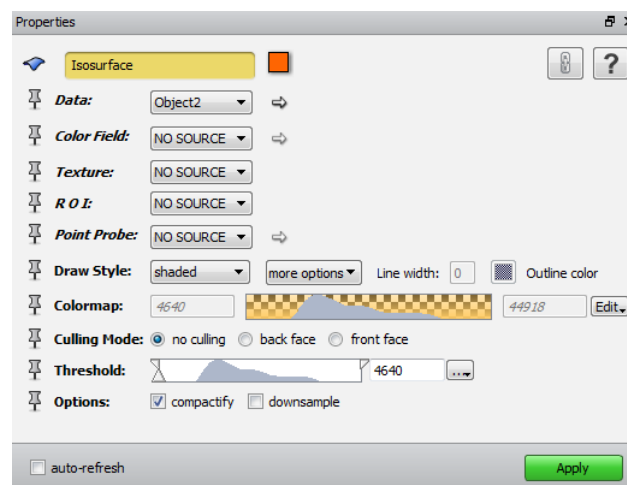

Figure 33 – Isosurface generation tool.

The threshold value depends on the structure to be isolated. Under the isosurface properties (Figure 33), select the threshold with the **Threshold** cursor and click on Apply. For display options, see Section 4.2.

To create a manipulable surface from an isosurface, select the **Extract Surface** tool and click on Apply. The result is a triangulated surface contained in a .surf object (Figure 34). The dimensions of the surface are displayed in its properties as number of points and faces. The subsequent sections will present the edition (4.3) and simplification (4.4) tools. The geometric transformation tool is similar to the one controlling the object presented in Section 3.6.

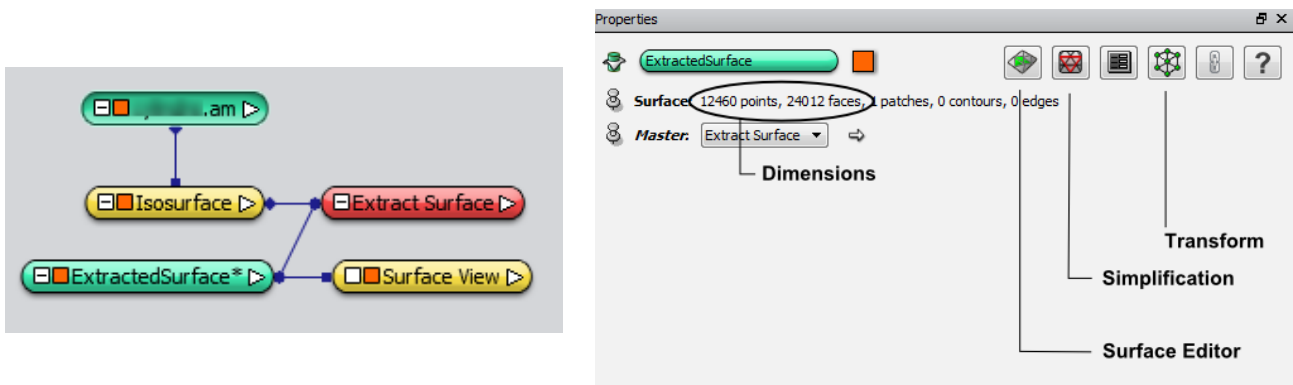

Figure 34 – Surface generation from an isosurface using the Extract Surface tool.

4.2 Viewing the surfaces

To visualize the surface, use the **Display/Surface View** tool from the .surf object. The surface appears in the main window. By default, the surface contains each region defined by the labels. The **Draw Style** menu enables the modification of the surface aspect and can make it transparent with the **transparent** field. The **Base trans** field appears and enables the modification of the transparency by adjusting the cursor to a value between 0 and 1. Figure 36 illustrates an example of a surface processed into transparency.

To process a particular region, select the corresponding label in the **Materials** list. Then select in the **Buffer** menu the appropriate function to add, remove, or draw this region.

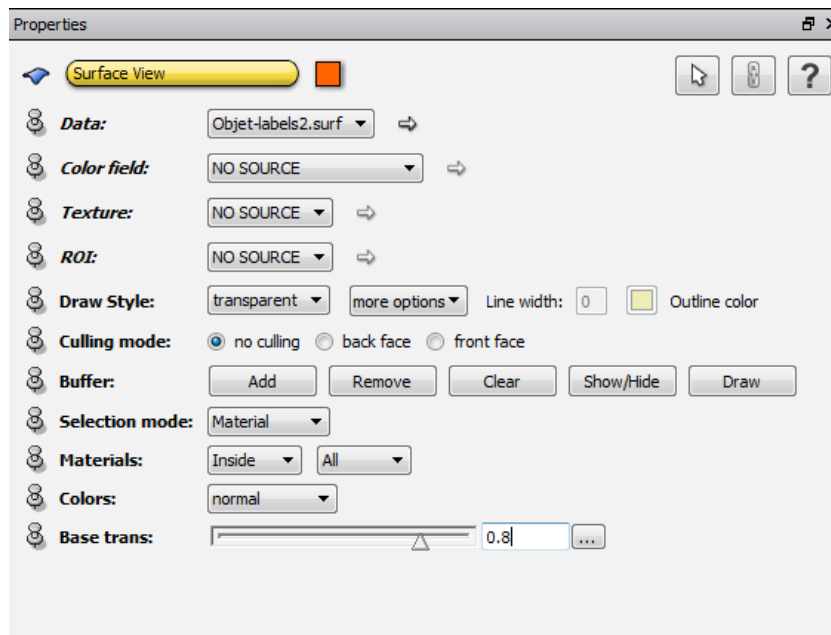

Figure 35 –Surface View tool.

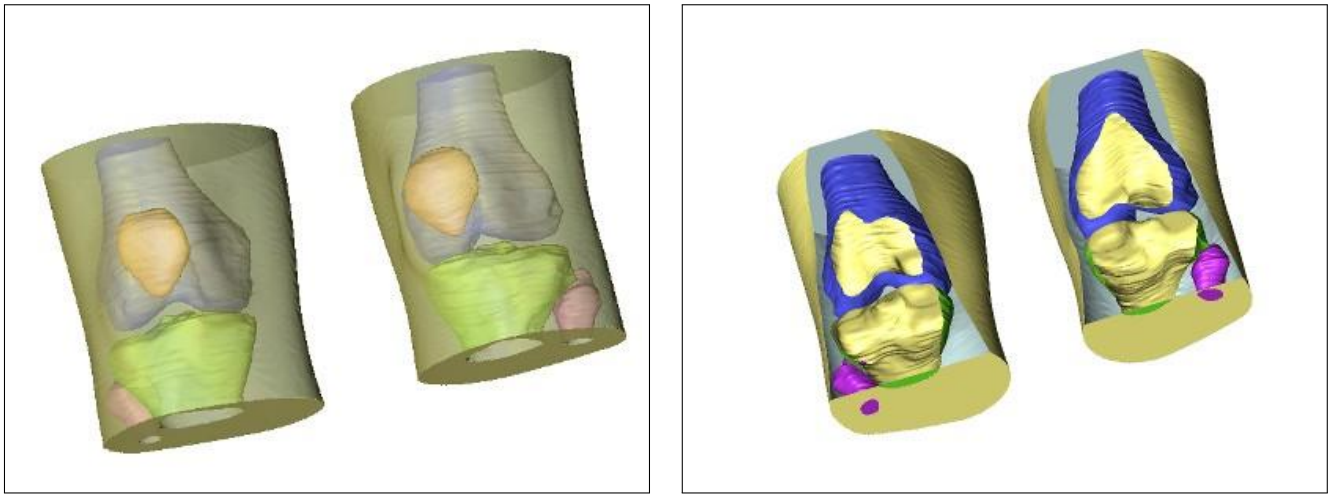

Figure 36 – Surface view with a transparency effect (left) and sliced along an oblique plane (right).

The **Ortho Slice** tool enables access to a slice of the surface. Under the tool properties, click on the Clip tool, see Figure 37. The surface is reduced at the level of the slice plane. To obtain the other half of the surface, click again several times on Clip. The same procedure is possible with the **Slice** tool presented in Section 3.1 to slice the surface along an oblique plane.

Do not display the Ortho Slice or Slice tools by clicking on the orange square to see through it. An example of a surface slice is presented in Figure 37.

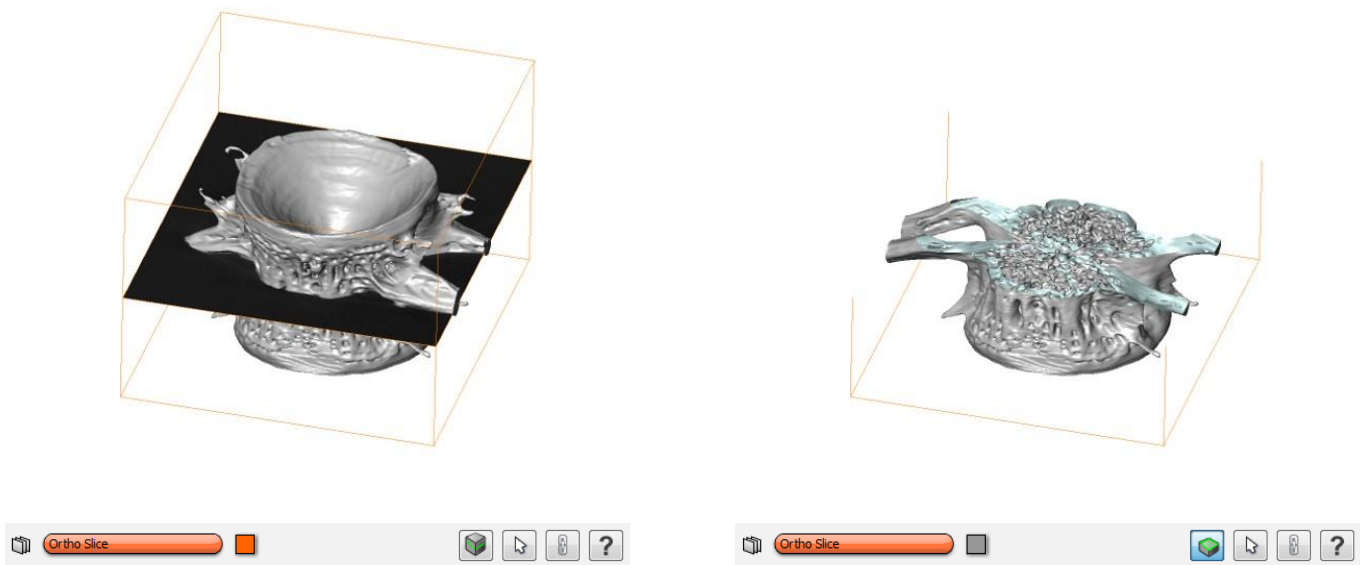

Figure 37 – Surface view from a slice plane.

4.3 Editing the surfaces

Prior to any surface modification, save the original .surf file and maybe simplify the surface beforehand (see Section 4.4).

Under the properties of the surface object, select the **Surface Editor** tool. This tool enables the local correction of the surfaces and the removal of sections. A new toolbar with three modules appear above the main window. A new menu titled **Surface** appears in the menu bar.

To apply a change to a triangle, the latter must be selected. The selection of a triangle is indicated in red color.

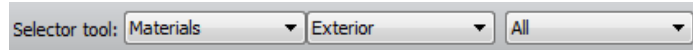

Figure 38 – Selection of the surface to edit

The first module is used to select the surface to be processed. The simplest way is to perform a selection by material. To do so, select the material of interest from the drop-down list. By default, the surface is labeled Inside and the selection is empty. Specifically, the selection contains the Exterior label triangles.



Figure 39 – Triangle addition and removal.

The second module is used to allocate the selected triangles to the buffer, remove them from the buffer, and empty the buffer.



Figure 40 – Triangle manipulation.

The third module is used for a local modification of the surface. The **Draw contour to highlight faces** tool provides the option to select triangles by circling them directly in the 3D view. To do so, make sure to select the **Interact** tool (the arrow in Figure 15). By default, all triangles in the depth of the drawn contour are selected. To add only the visible triangles, click on **visible triangles only** in the drop-down menu of this tool.

When the selection is correct, select in the **Surface/Edit** menu the process to be applied on the faces. Figure 41 illustrate the **Surface/Edit/Delete highlighted faces** operation.

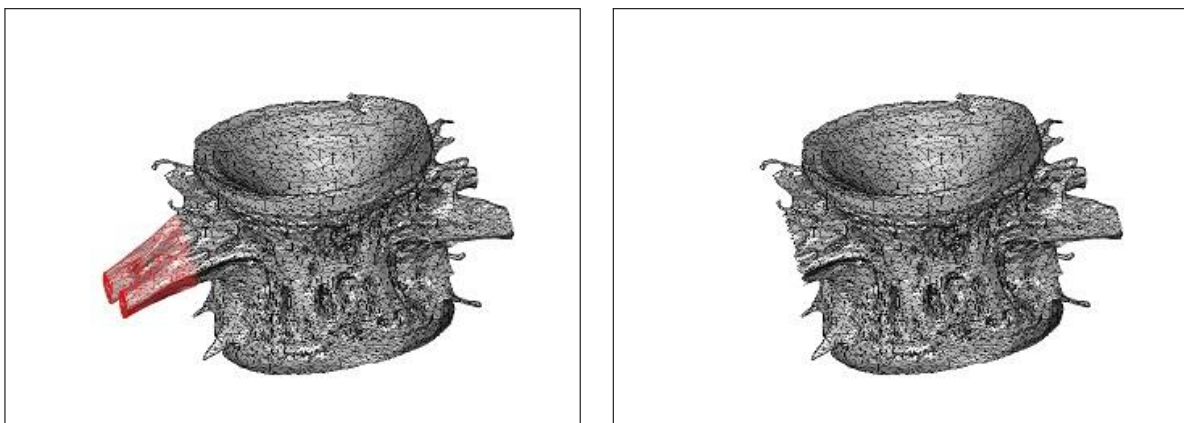

Figure 41 – Removal of part of the surface. Triangle selection with the Draw contour tool (left) and the result of the operation (right).

4.4 Simplifying the surfaces

The properties tab of the .surf object indicates the number of points and triangles (faces) which constitute the surface. The higher the image resolution, the higher the number of points. However, a high number of triangles might complicate the manipulation of the surface. Sometimes, it might be necessary to simplify the surface obtained before exporting it. To do so, use the **Simplification Editor** tool under the Properties tab (Figure 42).

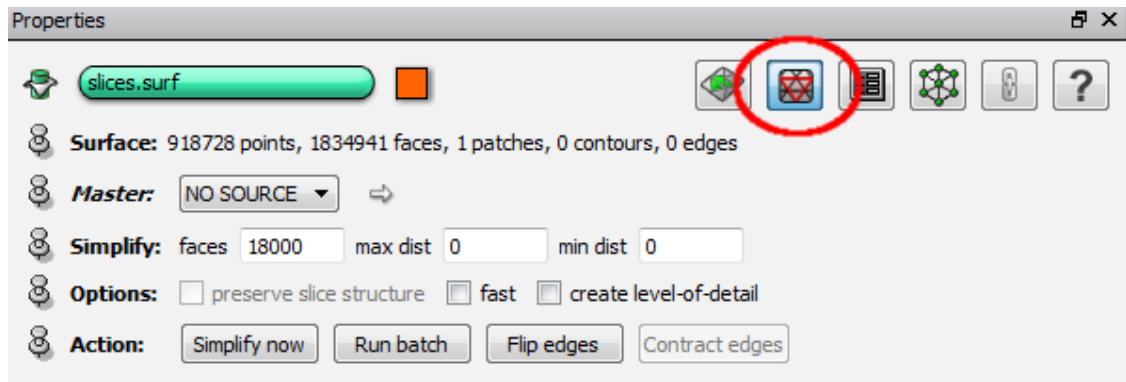

Figure 42 – Surface simplification module accessible from the .surf object Properties using the Simplification Editor icon (circled in red).

In the **Simplify** field, specify the number of faces of the new surface. Then click on **Simplify now**.

5 Segmenting the data

Images have to be segmented to define different regions in the scan volume. To do so, a label is attributed to each pixel for classification inside a given region. The label is characterized by a name and a color. Segmentation control involves the manipulation of the Labels object created with the **Image Segmentation/Edit New Label Field** tool.

The Labels object is a 3D image of the same dimensions as the data, with voxels coded in 8 bits (between 0 and 255). Each voxel of the Labels image will contain an integer (0,1,2...) corresponding to a structure defined by the user.
The Labels image is visualized in the segmentation environment by overlapping a color layer on the original 3D image.

The segmentation environment takes the shape of a tool window, the Segmentation Editor, and four viewer windows. The interactive 3D window is again available on the top left. The three other windows are orthogonal views (along the xy, yz and xz planes) of the 3D image. The user can scroll through the image slices using a cursor located at the bottom of each window or with the mouse wheel.

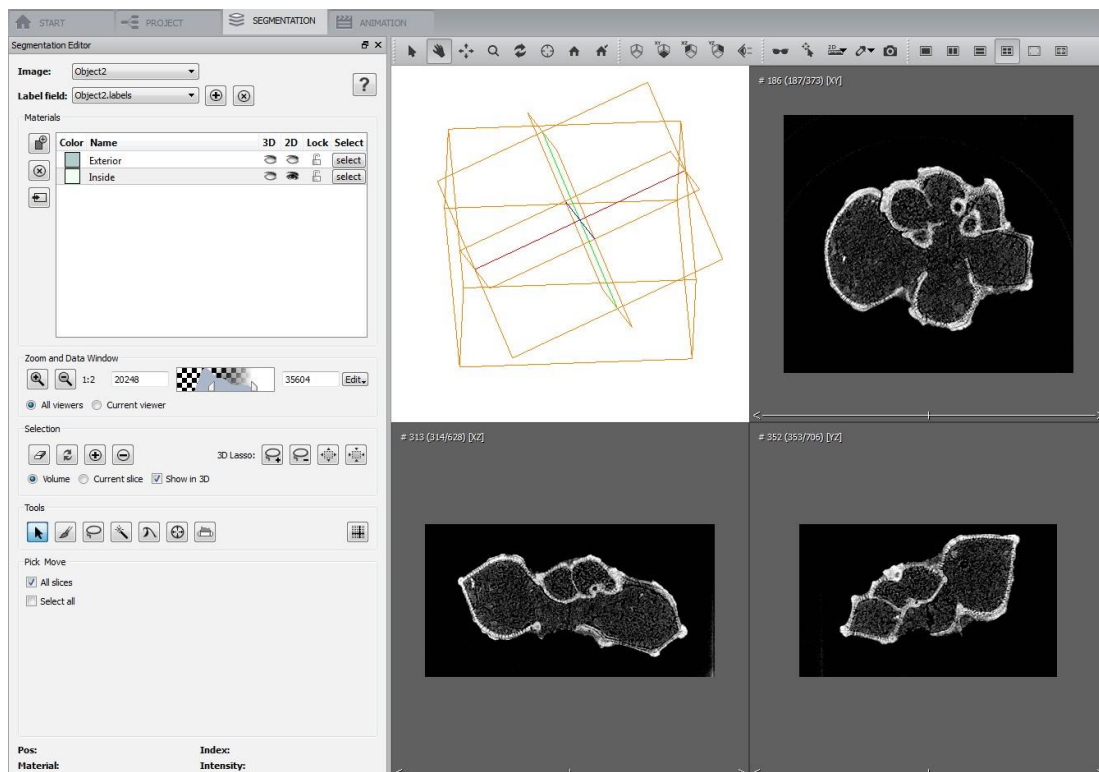

Figure 43 – The segmentation environment.

5.1 Editing the segmentation

In the **Segmentation Editor** tool, the Exterior and Inside materials are defined by default and the voxels are labeled Exterior. Several modules are used to process the segmentation:

- The Materials module

It is designed to manage the list of defined materials (or regions), Figure 44. A new material can be added by clicking on Add a new material; a material can be removed by selecting it on the list and clicking on Remove. Materials can be displayed or hidden by clicking on the eye icon and locked with the padlock. By right-clicking on a material, the user can rename it and modify its color. The label color will be allocated to the generated region. It is more comfortable to work with bright colored materials. The colors may be changed later for aesthetic reasons.

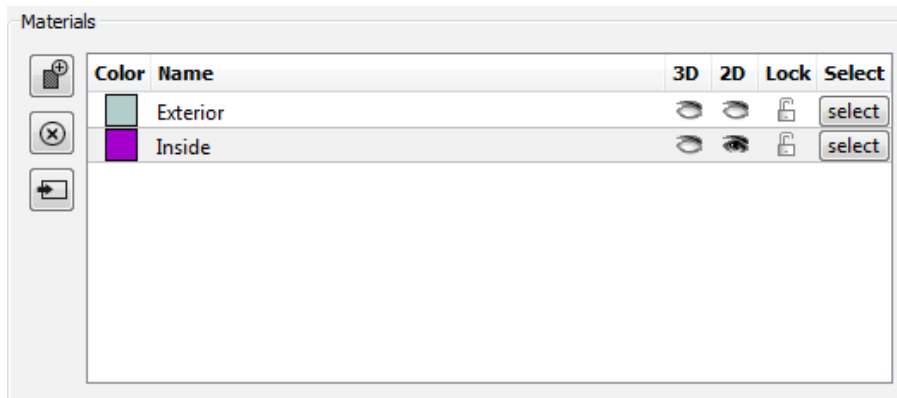

Figure 44 – The Materials module.

- The Zoom and Data Window module

This module controls the zoom level and is designed to adjust the contrast in the viewer windows of the orthogonal slices (see Section 3.4). To facilitate the segmentation task, do not hesitate to shift to full screen (using the tool in Figure 18) and to zoom to the maximum.

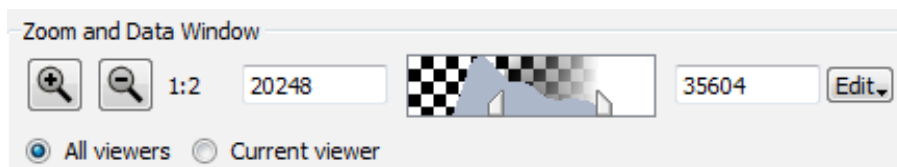

Figure 45 –The Zoom and Data Window module.

Modifications are assigned to each viewer or to the selected one by selecting All viewers or Current Viewer.

- The Selection module

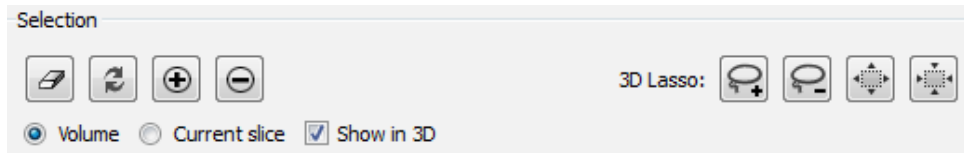

Figure 46 – The Selection module.

To segment an image with Avizo, a region of interest is colored and assigned to a material. The region of interest is defined using the tools found under the Tools module and appears in red in the different viewers. This set of pixels is called selection.

The eraser tool erases **the entire** selection. The + sign adds the selection to the material selected in the list and the – sign removes it. The lasso 3D tools are used to draw a region of interest directly in the 3D view and add or remove it in the selection. The Grow and Shrink tools respectively expand or restrict the selection of a voxel.

The selection can be displayed on the entire volume or only on the working slice. The Show in 3D box serves to visualize the selection in the 3D viewer. This is useful to get an overview of the surface rendering for the selection but can use a lot of resources. To reduce the calculations when the selection is significant, uncheck the box to deactivate volume rendering.

- The Tools module



Figure 47 – The Tools module.

- The **Pick and Move** tool redraws the selection of a given material, by clicking inside a labeled region, and moves it. The All slices box enables the user to manipulate all the slices of the region.
- The **Brush** tool draws directly the selection with a round brush (or square by selecting Square brush) for

which the size parameters can be adjusted (Figure 49). This is the basic tool for editing the segmentation.

The Limited range only box restricts the drawing by setting min and max thresholds for the selectable gray levels. This is particularly useful when the region of interest is highly contrasted relative to the surrounding regions.

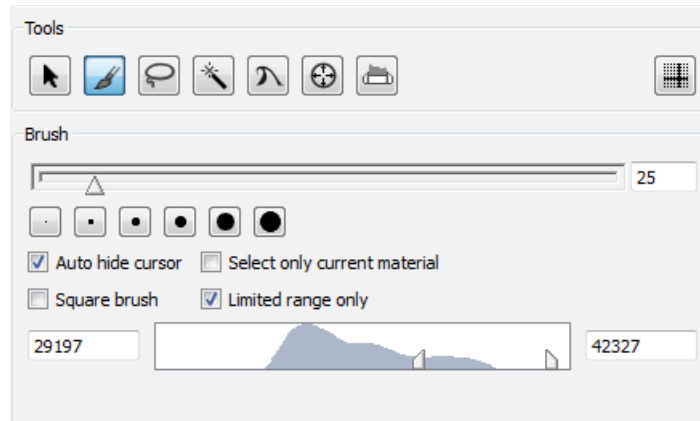

Figure 48 – The Limited range only option controls the gray levels of the pixels that will be selected with the brush.

The Same Material only box prevents the selection of a region that is already labeled.

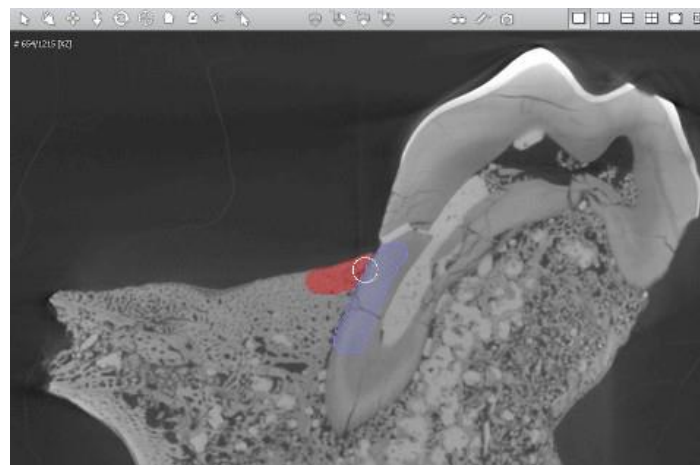

Figure 49 – An example of how the Brush tool is used when the Same material only option is checked. The new selection (in red) cannot go over a region already assigned to a material (hatching in purple).

By holding down the CTRL key, the Brush tool becomes an **eraser**.

- The **Lasso** tool defines a selection by tracing its contour manually (freehand) or using predefined shapes (ellipse or rectangle). The Auto trace option adapts the drawing to the image contours but only works when the contour is very sharp.
- The **Magic Wand** tool selects a structure from a given point by thresholding. The adjacent pixels are included in the selection if their values are between the min and max thresholds defined by the user. The selection can extend in 3D; the Magic Wand tool can rapidly extract regions for which the gray levels are homogenous.

First, click on a point inside a region of interest. The gray level of the selected point appears in red in the histogram (Figure 50).

Use the cursors to reduce the section of the histogram to the gray level range between the min and max thresholds and corresponding to the targeted structure.

Tick the All slices box to extend the selection to the adjacent slices. The Show in 3D tool of the Selection module is used to visualize the selected area in the 3D viewer.

The Same Material only box prevents the selection of a region that is already labeled, see Section 6.1. The Fill interior box is used to fill the gaps in the selected region and only works in 2D.

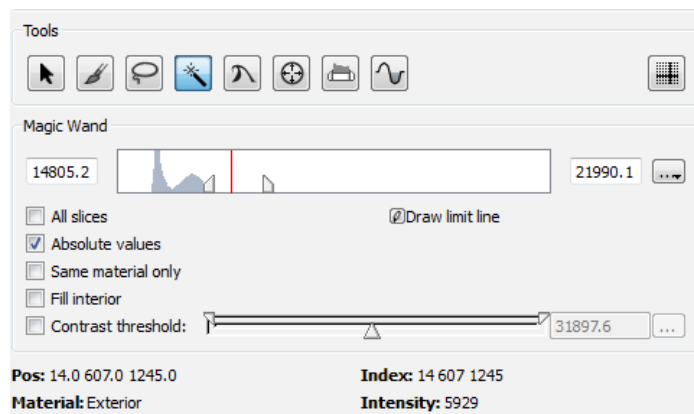
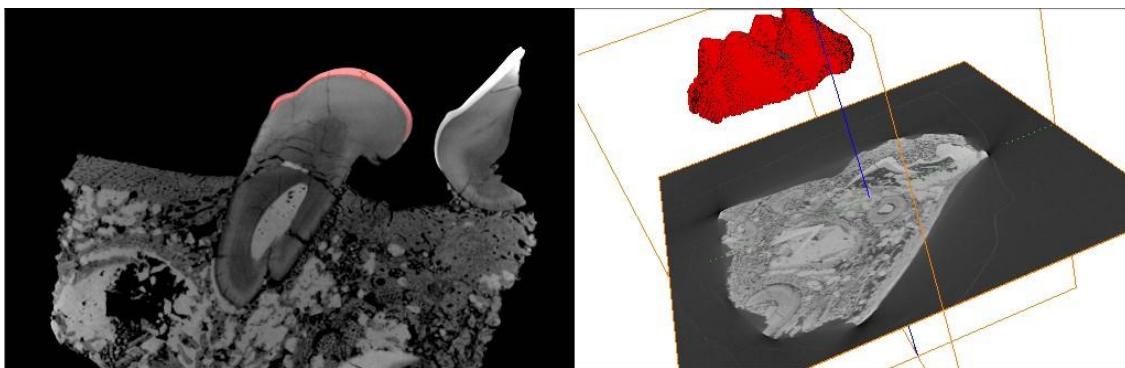

Figure 50 – An example of how the Magic Wand tool is used. The point selected on the image is displayed as a red cross (top left) and as a red bar in the histogram (top right). Reduce the selection area in the histogram to isolate the targeted structure. The All slices tool expands the selection and extracts the structure.

- The **Propagating Contour** tool is based on the active contour principle. From an initial point, the selection will iteratively expand to fill a structure, respecting its contours. The distortion of the active contour at each iteration will allow it to adapt to the image contours.

The contour propagation is controlled using parameters of edge sensitivity, image intensity, curvature, and image contour attractor. These parameters are adjusted under the Menu tab (see Figure 51). The propagation occurs at the level of the 3D volume or of a single slice. Click on DoIt to launch the iterations. When the calculation is performed, scroll through the iterations using the Time cursor. If the result is not satisfactory, modify the contour parameters. To change the initial point, click on Clear.

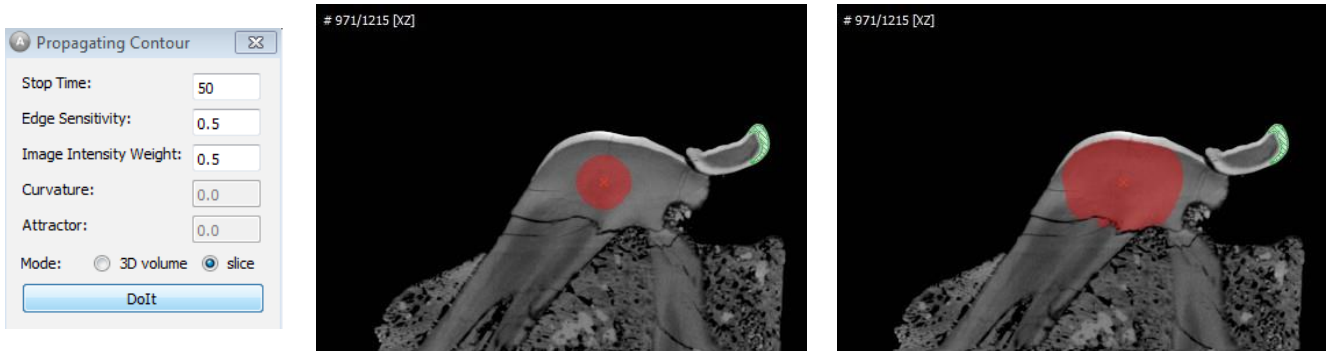

Figure 51 – Active contour propagation. Parameter adjustment (left) and result after 5 iterations (middle) and 11 iterations (right).

- The **Blow Tool** extends the selection area from a point by mouse control (Figure 52). The tolerance parameters influence the contrast needed for the image contours by forcing the contours to stay within their limits. Before the calculation, filtering is performed and the Gauss width parameter controls filter smoothing.

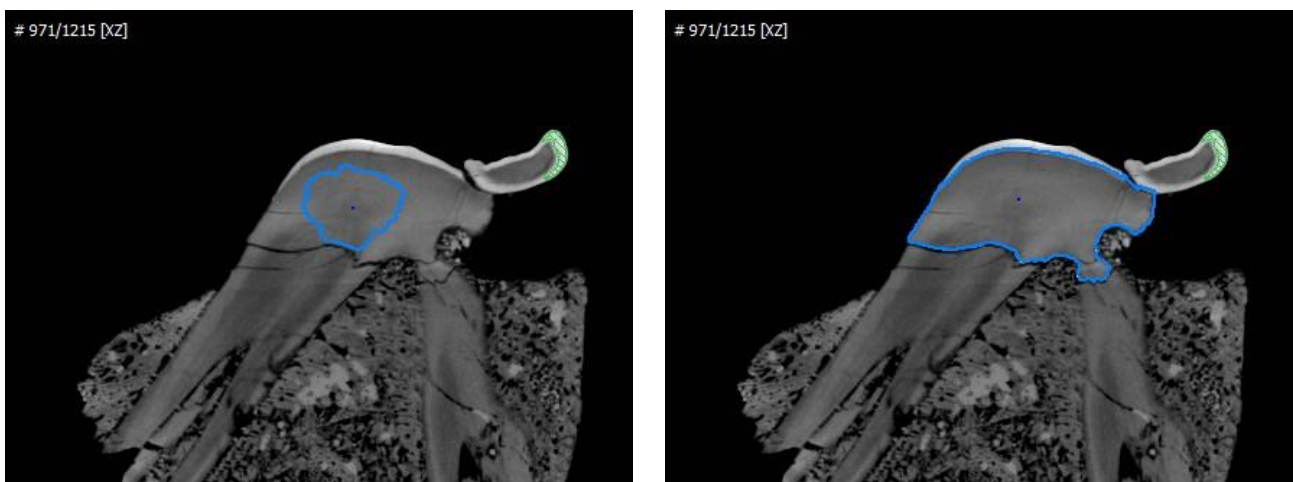

Figure 52 – Intermediary (left) and final (right) propagation steps with the Blow tool.

- The **Threshold** tool thresholds the image overall. The All slices box propagates the thresholding to all slices and the same Material only box prevents the selection of a region that is already labeled.
- The **Watershed** tool
- **Display a crosshair** displays the position of the cursor in each view by marking the slices with color lines.
- The information module located below the Tools module gives the information on the gray level and the material assigned to the point indicated by the cursor.

5.2 Global thresholding

When the data are contrasted enough so that the different regions can be automatically distinguished by their gray levels, all that needs to be done is defining the global thresholds. In the Image Segmentation menu, select the **Multi-Thresholding** tool (Figure 53).

By default, Avizo defines two regions, Exterior and Inside. To define several regions, add the names of the materials in the **Regions** box, separated by a space. They should be ranked by gray level order. The **Histo** button gives access to the histogram and enables the visualization of the gray level distribution to help define the thresholds.

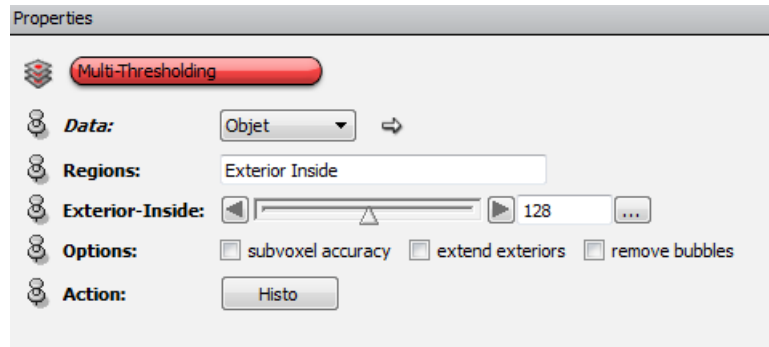

Figure 53 – Multi-Thresholding tool.

For example, to create three regions in the case of the teeth remnants in Figure 50, the regions can be characterized according to their respective thresholds (Figure 54). By clicking on Apply, a Labels type object is created in the Project View.

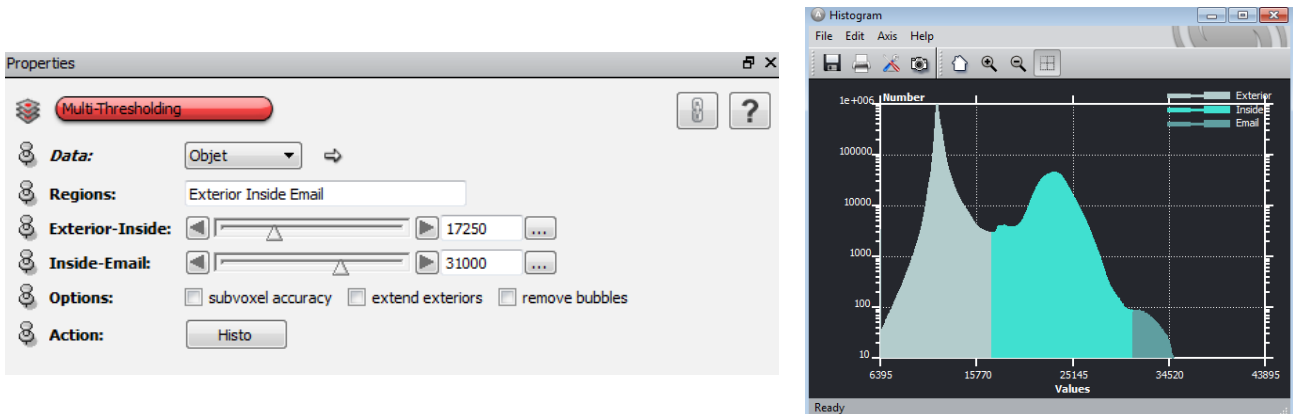

Figure 54 – An example of how to use the Multi-Thresholding tool to segment three regions.

This first process step classifies the voxels into labels. The created materials are editable in the segmentation environment.

5.3 Generating the surfaces corresponding to the segmentation

The surface corresponding to the labeled region can be visualized at any time during the segmentation. To do so, select the **Generate Surface** tool from the labels in Project View. The software considers the 3D image of the labels and constructs the corresponding 3D surfaces according to the marching cubes algorithm¹.

When several labels are defined, the surfaces from each label are created.

Before generating the surfaces, make sure to modify the label colors so that they correspond to the desired rendering type.

The **Smoothing** parameters control surface smoothing: none results in a rough surface and unconstrained or constrained smoothing include a label smoothing step before the generation of the surface. Be careful, if the smoothing is too high (smoothing extent parameter), the surface details will be lost.

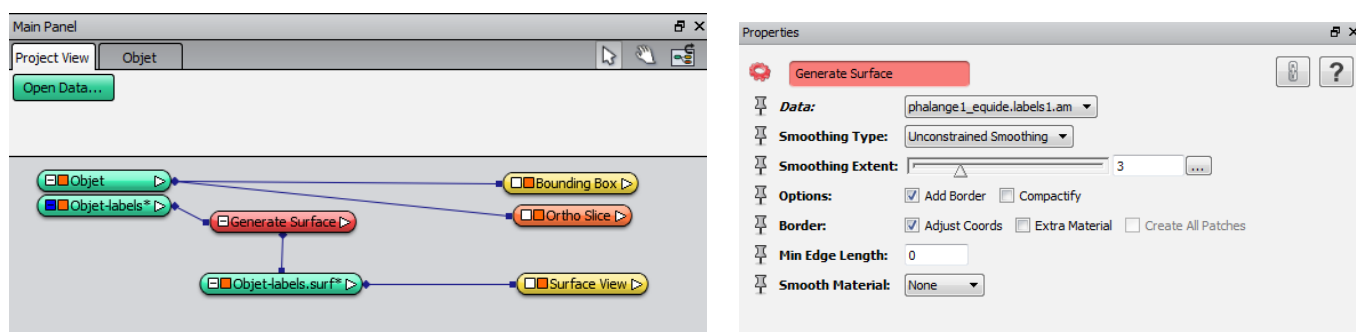

Figure 55 – Generation and visualization of the segmented surfaces.

When the generated surface is too big (in terms of number of generated triangles), the software might be very slow and/or unable to generate the surface. An error message similar to the one in Figure 56 appears. Sometimes, the software is able to calculate the surface within a reasonable timeframe; make another attempt by clicking on Continue.

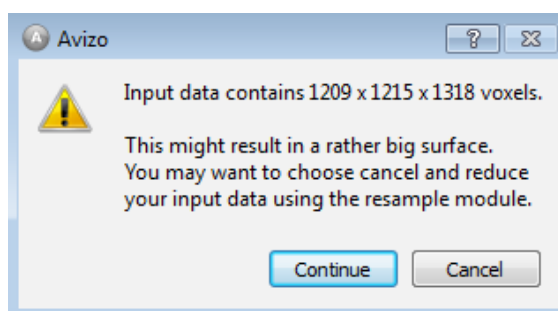

Figure 56 – Message warning to subsample the labels.

If this does not work, the labels must be subsampled. To do so, use the **Compute/Resample** tool from the Labels object. This tool averages the labels over several voxels. The reduction factor is specified in the **Average** field, see Figure 23.

The result is stored in a .surf object, visualized with a module Surface View, see Section 4.2.

The generated surfaces can be saved under the Avizo (.surf) or exported to other formats (STL, PLY, etc.).

¹ Lorensen, William and Harvey E. Cline. Marching Cubes : A High Resolution 3D Surface Construction Algorithm. Computer Graphics (SIGGRAPH 87 Proceedings) 21(4) July 1987, p. 163-170)

6 Advices and tips for the segmentation

6.1 Restricting a Magic Wand tool selection

The **Magic Wand** tool extends the selection of a region of interest using the gray levels of an image but cannot capture the notion of contours. Often, the structure to be isolated is adjacent to other structures with similar gray levels. The example in Figure 57 shows the case of a femur segmentation. The threshold values needed for the selection require the selection of the entire skeleton under the **All slices** command.

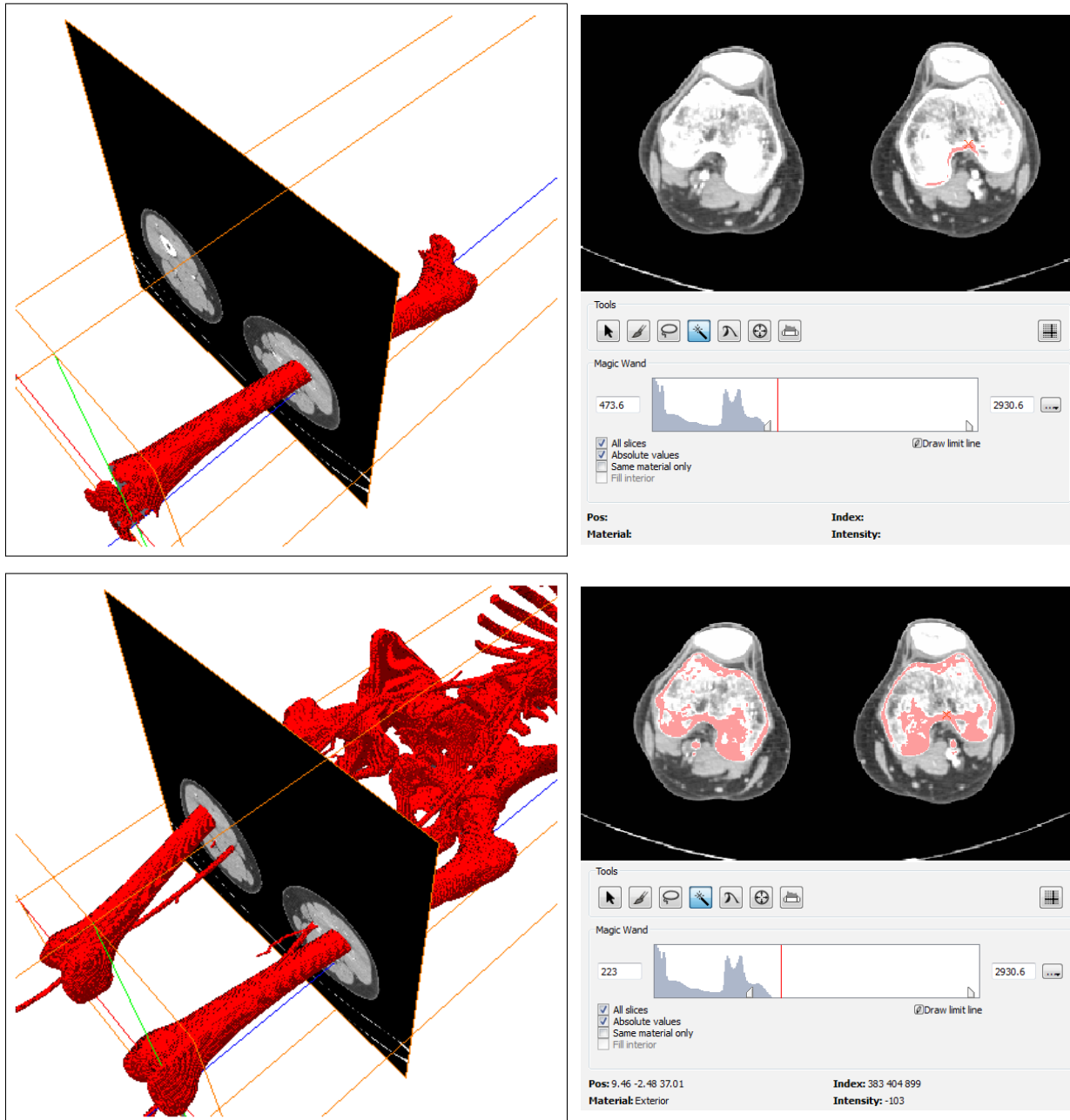

Figure 57 – A restricted thresholding of the gray levels is not enough to select completely the structure of the femur (top images). However, extended thresholding results in the selection of unwanted structures (bottom images).

Instead of manually completing the selection of the top images in Figure 57, it is possible to control the propagation by isolating the desired structure.

6.1.1 By creating a border material

To do so, define a new material that will serve as a border when using the magic wand. Locate on the 2D slices the areas where the contact occurs between the structure of interest and the others. Assign the voxels that are problematic for the new material to all the slices where there is a contact.

Figure 58 illustrates this method. The material in green was created to prevent the propagation of the selection to the adjacent bone. When using the magic wand, the **Same material only** option restrains the propagation of the selection.

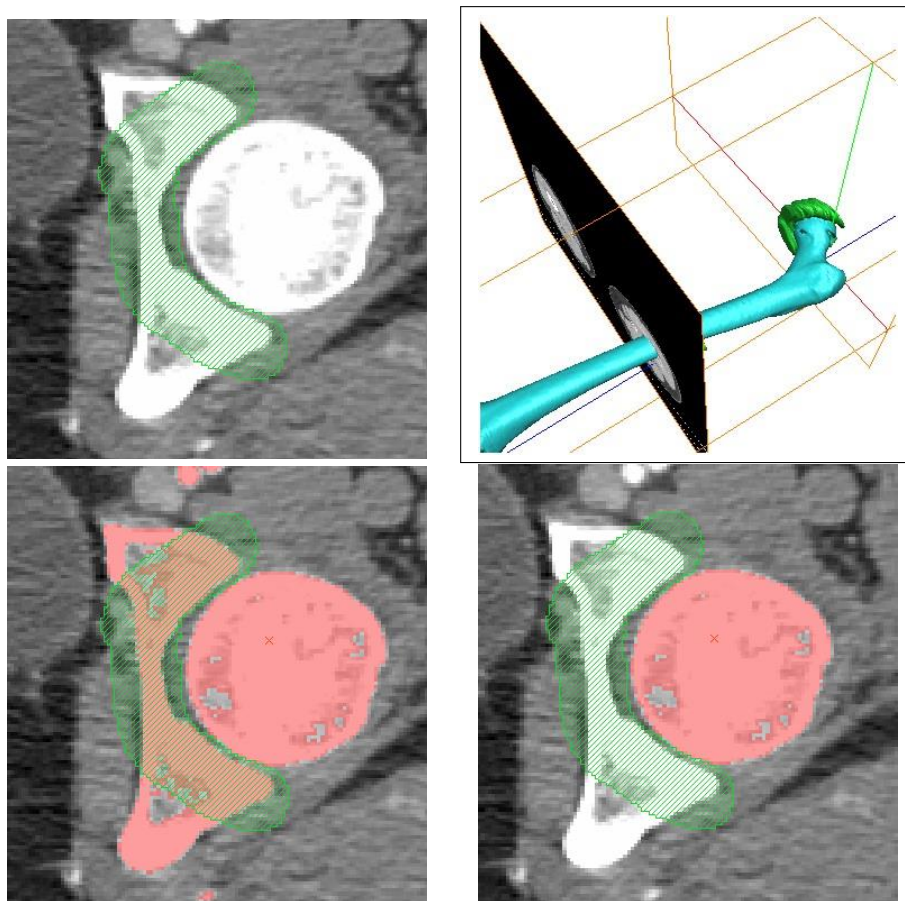

Figure 58 – Delineation of the structure with another material (in green). Propagation with All slices without (bottom left) and with (bottom right) the Same material only option.

6.1.2 On a slice with Draw limit line

The **Draw limit line** option of the Magic Wand tool enables the edition of a border using a pencil directly on a slice. Figure 59 presents the case of the separation of two bones. The extent of the magic wand is limited by the drawn line.

Please note that this border is done only in 2D and has to be described on each slice before propagation in 3D with the option All slices.

6.2 Creating the surface corresponding to a specific material

When viewing the surface corresponding to a material, the surface rendering step is unnecessarily encumbered by the generation of all surfaces. To isolate a material of interest, use the **Compute/Arithmetic** tool from the Labels object. Under the properties of the Arithmetic module, verify that input A is the label card, see Figure 60.

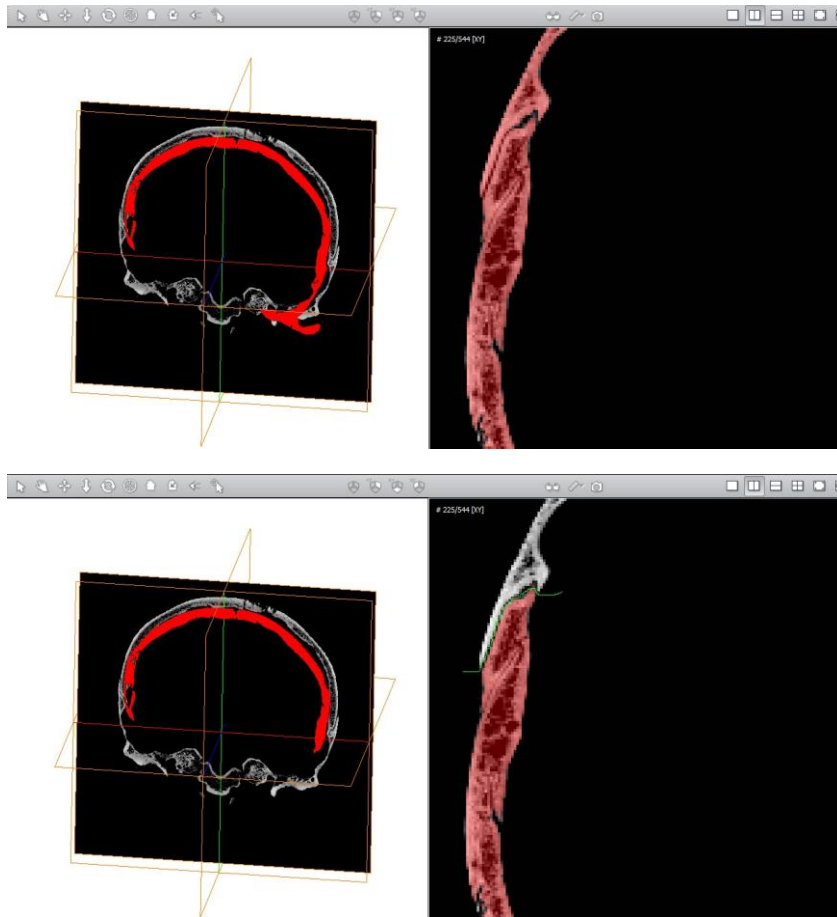

Figure 59 – The magic wand has no threshold values that can both select the entire bone and exclude the other (top image). Therefore, the separation must be drawn with the Limit line tool before proceeding to the propagation.

The label card has integer values that are numbered 0 for the exterior, then 1 for the first material on the list, 2 for the second, etc. To extract a material (for example, the third) enter in the **Expr** field a formula of the type $A==3$. To extract several materials, use the logic operator OR represented by the sign $||$ (AltGr+6). For example, to isolate materials 2 and 4, the expression is $(A == 2)|| (A == 4)$.

This manipulation creates a label card to generate a surface. However, this card is no longer attached to a dataset and therefore, it cannot be edited. To generate an editable label card, see Section 6.3.

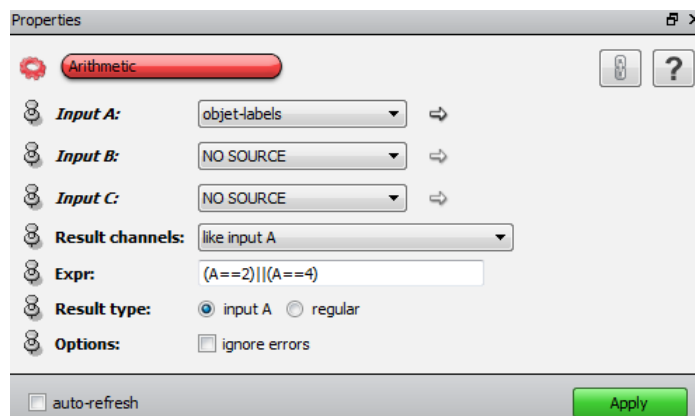

Figure 60 –Arithmetic module to extract one or several materials.

6.3 Reducing the labels to materials of interest

When many « working » materials are created, they become redundant. Of course, they can be deleted but if the user wishes to keep them for future modifications, it is better to extract materials of interest.

To do so, use the **Compute/Arithmetic** tool to generate a new set of labels using an arithmetic or Boolean operation. The Arithmetic module performs on 1 to 3 objects. To separate the labels, the module must be linked to the images (Input A) and to the labels (Input B). These links are defined from the tree structure in the Project View window or under properties, see Figure 61.

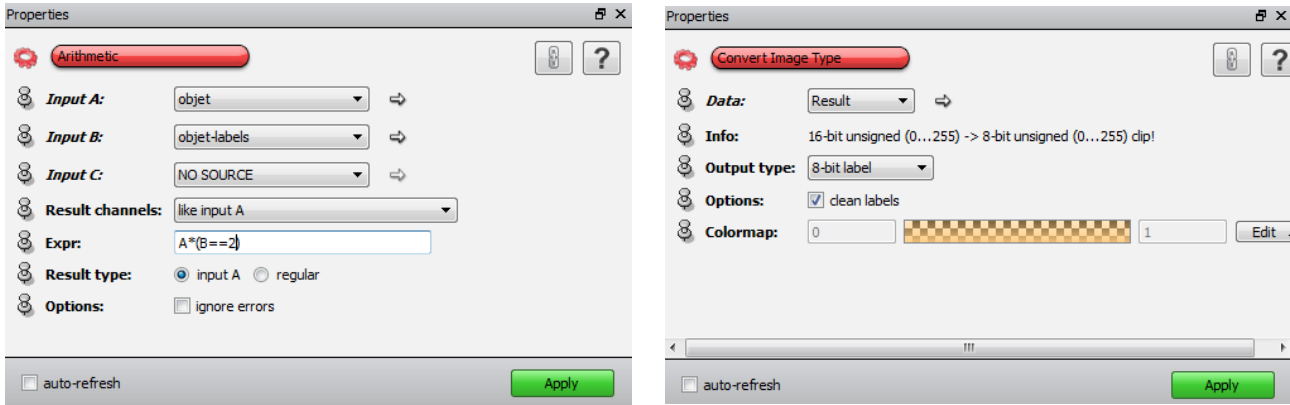

Figure 61 – Properties of the Arithmetic tool and the ConvertImageType tool

The operation is defined in the **Expr** field by a formula including the object and the labels. The formulation detail is presented in Section 6.4.

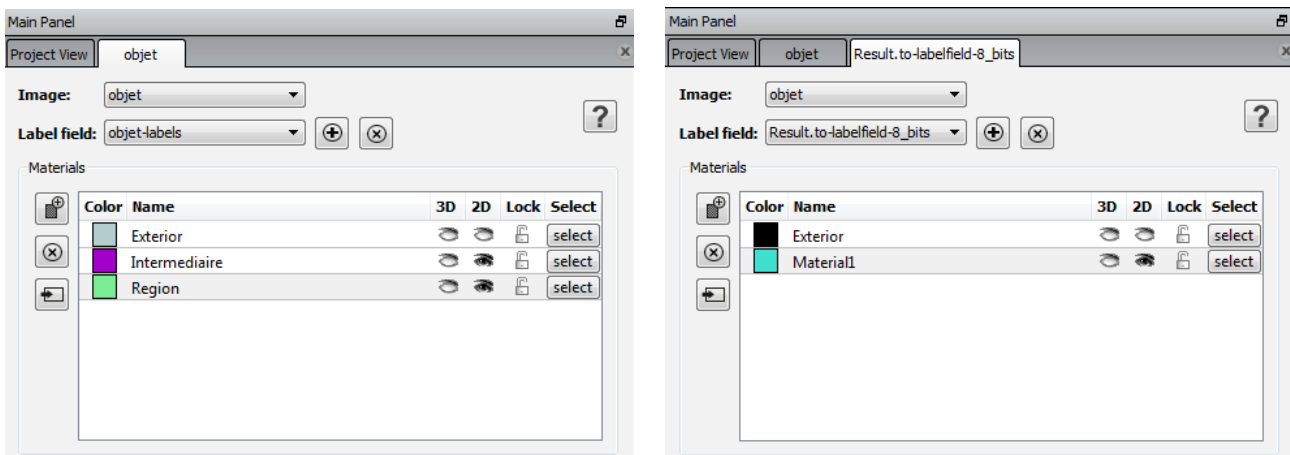

Figure 62 –Materials module of the object segmentation (objet-labels left) and the result of the arithmetic operation (Result.to-labelfield-8 bits right).

To obtain a new label card, the result of the operation must be converted with the **Convert/Convert Image Type** tool (Figure 61) by modifying the **Output Type** field in a 8-bit label. The **Clean labels** option removes the empty ones. The result of this conversion serves as a new label card. Figure 63 illustrates the tree structure of this manipulation.

6.4 Arithmetic and Boolean operations on labels

To manipulate the labels, the user has to start from a set of images as Input A and a label card as Input B. The created object will be of the same type as A, namely images with gray levels coded in 16 bits. The label card has integers numbered 0 for the exterior, 1 for the first material on the list, 2 for the second one, etc.

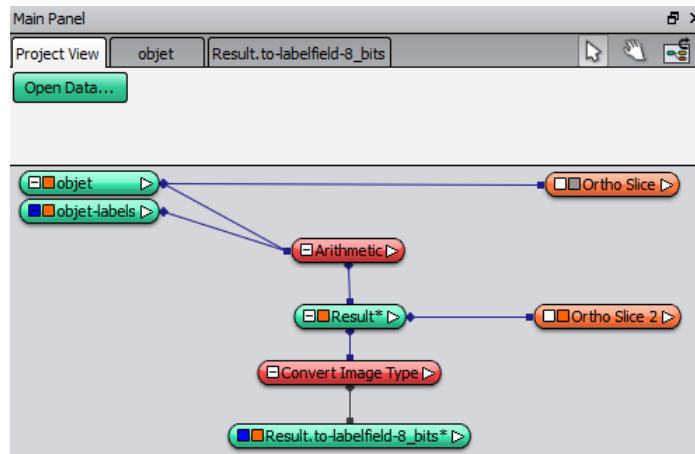

Figure 63 – Steps for the generation of a new label card from an original segmentation containing unwanted materials.

To sort the A pixels to be kept, A is multiplied by a mask value of 0 or 1. The pixel keeps its value for $A \times 1$. It has a value of 0 for $A \times 0$.

In the example in Figure 62, the segmentation of the region of interest requires the construction of an intermediary label that is unwanted. Here, the only material to be kept is the one indexed 2. The extraction formula (Figure 61) involves keeping only the pixels labeled 2. The logic equation $B == 2$ will have for result 1 (true) for the pixels labeled 2 and 0 (false) for all the others. Therefore, the complete expression of this arithmetic expression is $A \times (B == 2)$.

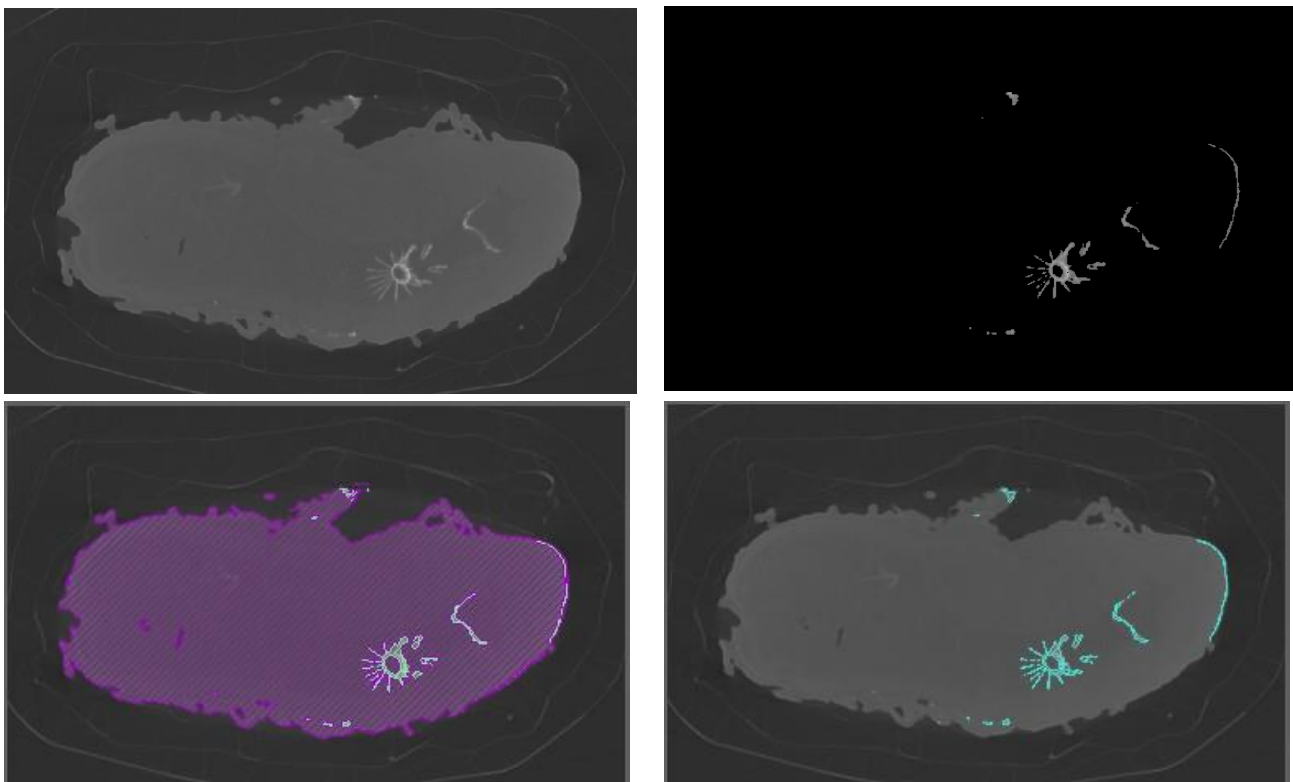

Figure 64 – Effect of the Arithmetic operation presented in Figure 63. Original image (top left) and resulting image (top right). Original labels (bottom left – intermediary in purple and region in green) and resulting labels (bottom right – material 1 in blue).

It is possible to [combine two materials in the same label](#). To do so, use the Arithmetic tool presented in Section 6.1 and the Boolean operation OR represented by the sign \parallel (AltGr+6). To create a new label combining labels 1 and 3 of B, the expression is $A \times (B == 1) \parallel (B == 3)$. When the labels to be combined are indexed successively (for example, 3, 4 and 5), the operators $>$ and $<$ are also provided. The expression will be of the type $A \times (B > 2)$.

7 Exploiting the results

7.1 Measuring

The measurement tool is accessible from the **Create/Measure/Measurement** menu or the toolbar in Figure 17. The Properties tab enables the edition of distances and 3D angles. The pick mode should be **Accurate** rather than Fast. **Snapping** (the magnet) should be deactivated (Figure 65).

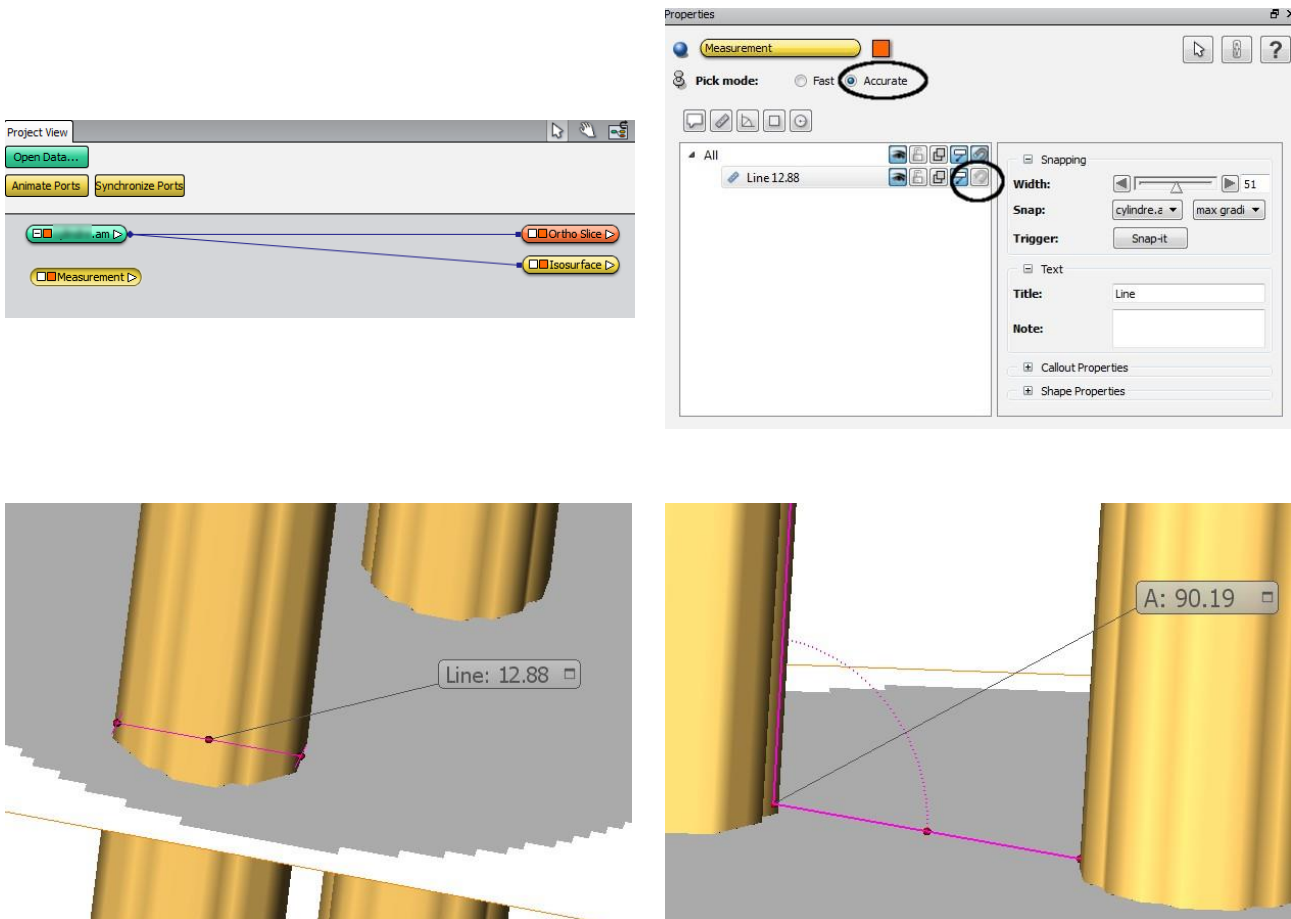

Figure 65 – The Measurement tool (top) and calculations of a 3D distance on an isosurface (bottom left) and of a 3D angle (bottom right).

The interaction cursor displays an M to indicate that it is possible to place a point. To modify an existing point, click on it and move it by holding the left button down. When measuring an angle, manipulate the points located in the middle of the segments to move one point at a time.

At any time, shift to the Trackball environment (the hand) to manipulate the object and angle it in the configuration where the point is the most accessible.

The colors and the dimensions of the measurement label are editable in the Text, Callout Properties, and Shape Properties menus.

The **SurfaceThickness** tool computes the thickness of a surface in each triangle by measuring the distance to the nearest triangle in a normal direction.

The result of this measurement is scalar for each triangle of the surface and is stored in an object named after the surface with the extension `.Thickness`.

Visualize this measure by using the **Surface View** module and by adapting the Colormap to the min and max thickness values.

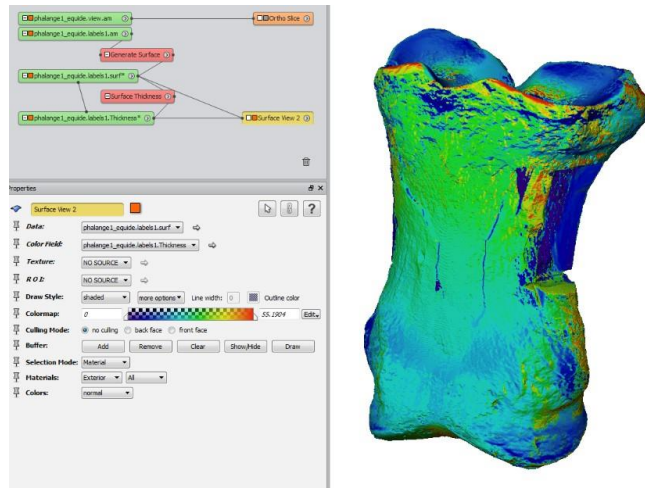

Figure 66- SurfaceThickness tool to measure the thickness of a surface and its visualization with SurfaceView.

The **SurfaceStatistics** tool provides information on a surface in a spreadsheet format.

7.2 Setting landmarks

The software provides an interface to interactively set points of interest (landmarks) on a surface and save their 3D coordinates.

Click-right on the background of the ProjectView window, then select the **Create Object** command. Select the creation of a **Points and Lines / Landmarks** object.

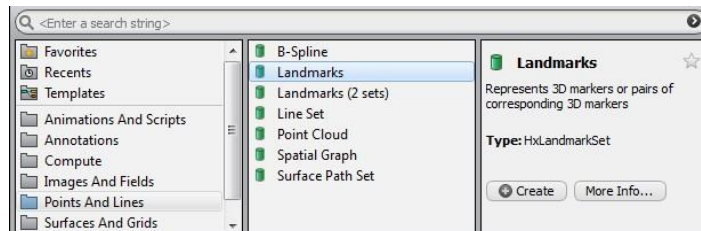

Figure 67 – Creation tool for a dataset of the Landmarks type.

The edition of the landmark is controlled by the **Landmark editor** accessible from the Landmarks module properties (Figure 68).

To add new landmarks, select **Edit mode Add** and set points on the surface with the Interact tool (the arrow in toolbar 15) that is active in the 3D viewer window.

Use the Trackball tool (the hand in toolbar 15) to position the surface so that the landmark is accurately set. However, it is possible to refine the position of the landmark later by displacing it. Note that a landmark can only be set in contact with a triangle of the surface.

To modify or remove landmarks, select the corresponding edition mode (Move or Remove) and follow the instructions at the bottom of the software window.

The aspect of the landmarks is configurable with the **Landmark-View** module associated with the Landmarks module.

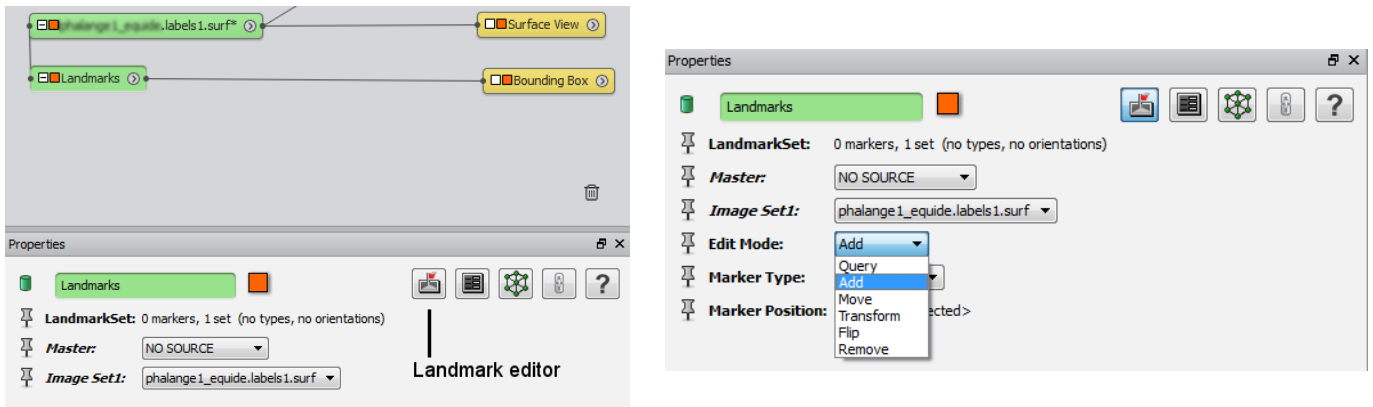

Figure 68 – Landmarks Editor tool.



Figure 69 – Modification of the aspect of landmarks with the Landmark-View tool.

Decide in which order the landmarks will be set on the surface before placing them. The Move option does not modify the position of the landmark in the list.

The data associated with the Landmarks can be exported under the ascii format and appear as a list of 3D coordinates. This file is exploitable with a text editor.

7.3 Exporting snapshots

To save the image on the main window, use the **Snapshot** tool in the toolbar Figure 17. The view can be exported to a file or a printer or copied to the clipboard. The dimensions of the image are linked to the default screen resolution, but they can be modified in **Offscreen width and height**.

Select a file name, a destination, and a format. Note that the PNG format associated with a **rgb alpha** type export makes the background transparent. This allows an easier import of the image to documents such as presentations or posters.

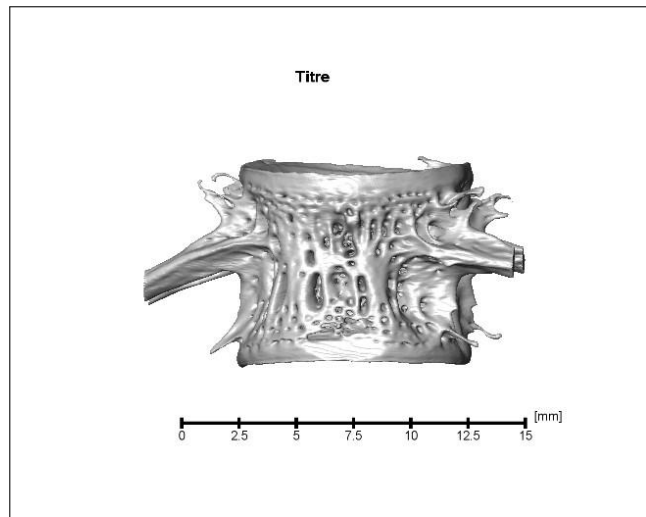
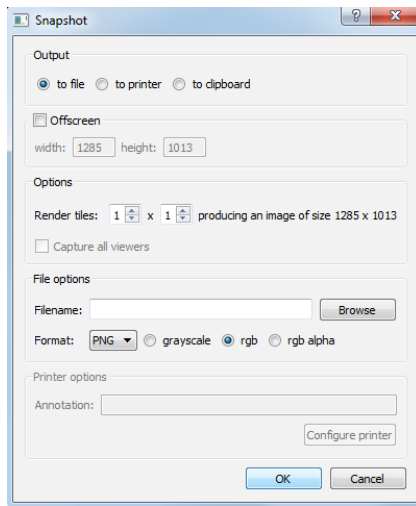

Figure 70 – Saving a view from the main window.

The information on the image exported in Figure 70 were added using the following tools:

The **Create/Scalebars** tool adds a scale to the image. The scale properties are editable under properties, see Figure 71.

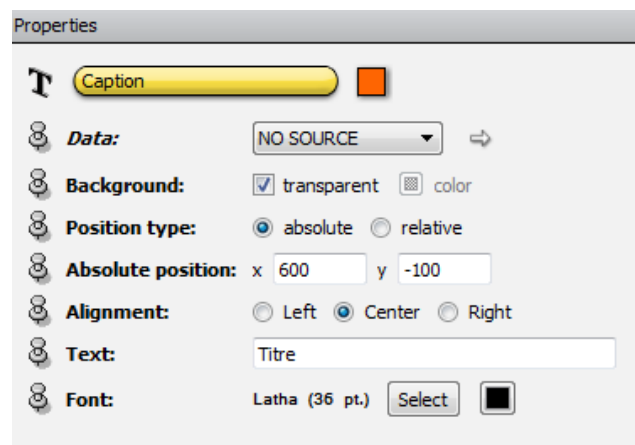
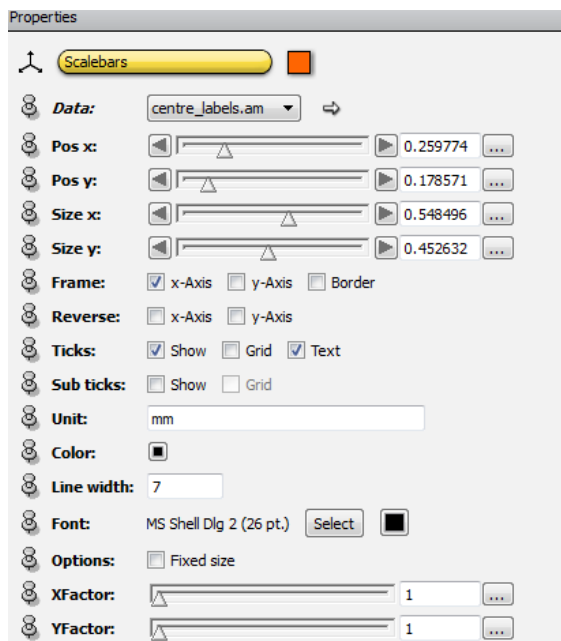

Figure 71 –Scalebars and Caption tools for editing an image for export.

- Data: the data to be characterized by the scale
- Pos x, Pos y: place the origin of the image scale
- Size x, size y: modify the length of the scale
- Frame: indicates the axes provided by the scale
- Reverse: allows reverse graduation
- Ticks and Sub-ticks: modify the graduations
- **Unit: gives the unit (in mm).**
- Color, Line width, Font: modify the font of the scale. Do not hesitate to increase the size to make it visible on the exported image as the latter will probably be reduced.
- Fixed size, XFactor, Yfactor: These parameters influence the size of the object. Do not modify them.

The **Create/Caption** tool adds a caption or a title to the image.

7.4 Creating a video

The video creation environment is accessible via the Animation tab and has the appearance of a control window associated with a timescale (Figure 72). This interface is similar to most video editing software. The point is to associate events (camera rotation, visual effect, etc.) to a time or duration in the final sequence.

The Project View environment project now have a timer icon at the left of the parameters than can be animated.

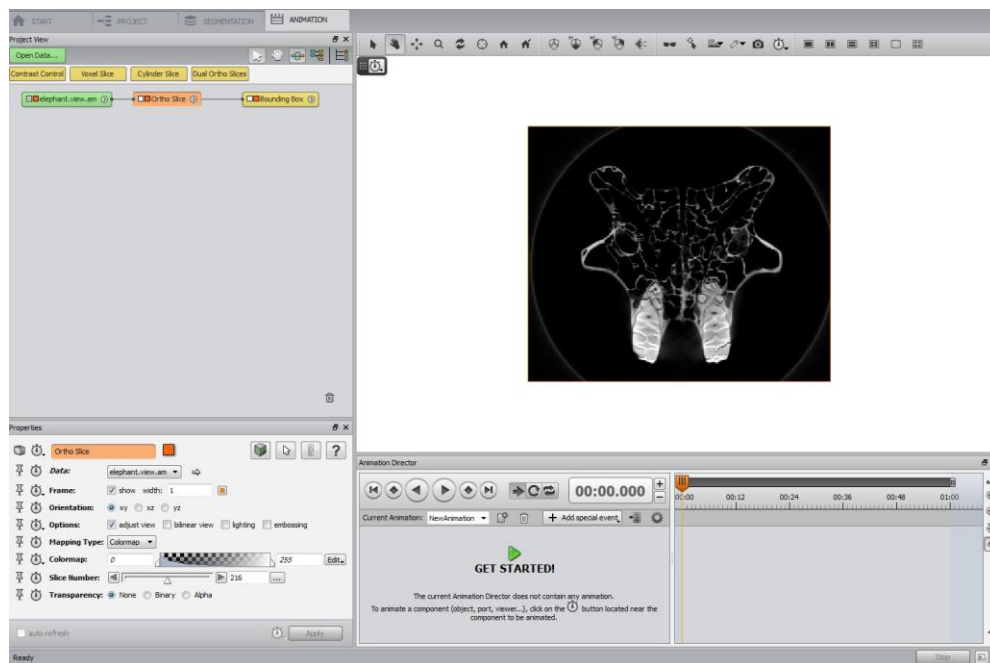

Figure 72 – The Animation environment.

The different objects presented in Project View must be adjusted as desired for the beginning of the video, in terms of position, color, etc. To change the background color, several options are offered in **View/Background...** It is possible to display a marker or a grid with the Global Axes object under the **View/Axis** menu.

The events can be punctual, of a defined duration or for the entire length of the video.

7.4.1 Slice browsing

To create a scrolling video in the images along a given direction, the variable parameter in the video is the **Slice Number** of an Ortho Slice module.

Select the initial view by positioning the Slice Number on the first image appearing on the video. Click on the associated timer. An event titled Ortho Slice / Slice Number is created in the Animation Director window at time 00 :00 (Figure 73). By hovering the mouse over the orange diamond, the symbol of the initial event, the user can verify if the event has the right parameters (in this example, slice 216 at t=0).

Move the orange time cursor to the end of the event (in seconds). Select the final view by positioning the Slice Number on the last image to appear on the video. Click again on the timer. This creates the final animation event with the selected parameters (here, slice 431 at t=1 min).

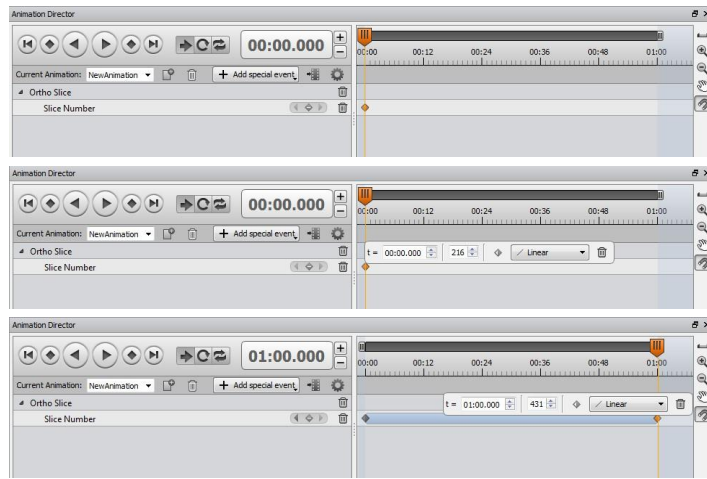

Figure 73 – Creation of a 1-minute animation scrolling from slice 216 to slice 431.

7.4.2 Camera rotation

To film an object rotation, create the Camera-Orbit object from the menu linked to the right click in the Project View window **Create Object/Animations and Scripts/Camera Orbit**. Select the rotation axis in the scrolling menu of the Action menu. Scroll with the **Time** cursor to verify that the rotation axis is the desired one.

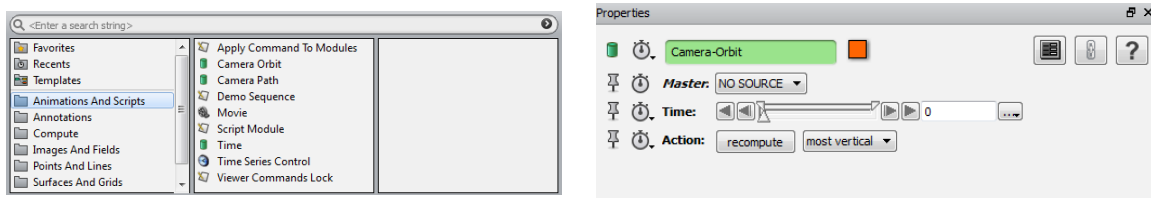

Figure 74 –Camera Orbit tool.

The variable parameter is the rotation angle (between 0 and 360 degrees) controlled by the **Time:Value** cursor; the associated timer generates the events for the animation.

As for slice browsing, an initial angle is selected for a given time and the associated event is created by clicking on the timer.

Then, place the time cursor of the timeline at the time selected for the end of the rotation. Adjust the Time cursor of the Camera-Orbit module on the final rotation angle. Click again on the timer to create the final event.

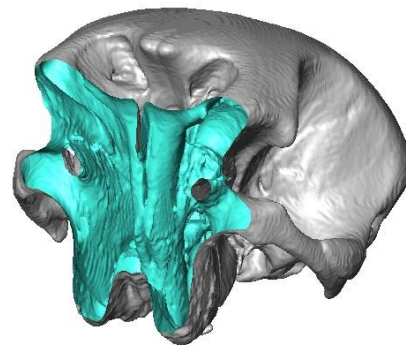
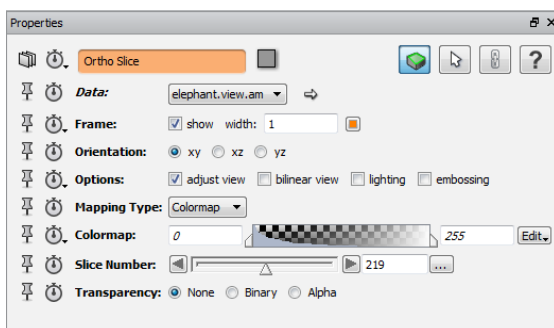

Figure 75 – Tracking on the 3D surface.

7.4.3 3D surface browsing

In the **OrthoSlice** object, the Clipping function clips a 3D surface along the plane controlled by the slice (Figure 37).

An interesting animation is to display a surface gradually, slice by slice. To do so, the user creates the slice browsing event with SliceNumber as described above, making sure to deactivate OrthoSlice display and activate clipping (Figure 75).

7.4.4 Gradual transparency

For an object to gradually become transparent during the animation, it has to be designated as transparent initially in the Draw Style menu of the surface properties. The Base trans cursor adjusts the transparency from 0 (normal) to 1 (invisible). Then, select the timer associated with the **Base Trans** parameter to modify the transparency value between two moments (Figure 76).

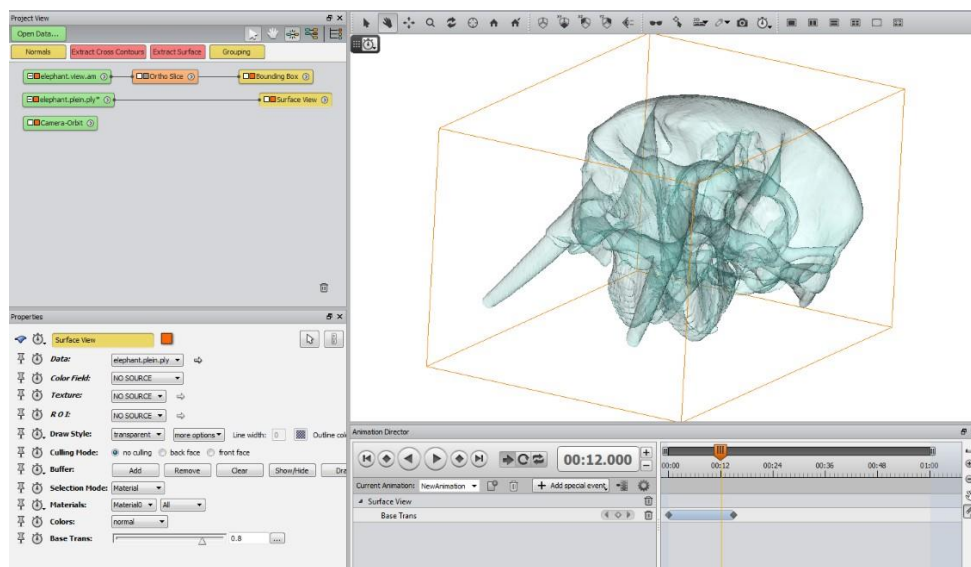

Figure 76 – Creation of an event to make an event gradually transparent and fade at t=15s.

7.4.5 Exporting the video

To export the sequence programmed in the Animation Director environment, select the button represented by a film icon (Figure 77). Select the film format (MPEG or AVI) and a name for the file.

The number of images (frames) will determine the final length of the video; this information is found in the Info line. Select the video definition in number of pixels with the predefined values (in Size) or by selecting Custom for customized values.

The Create Movie button launches the export.

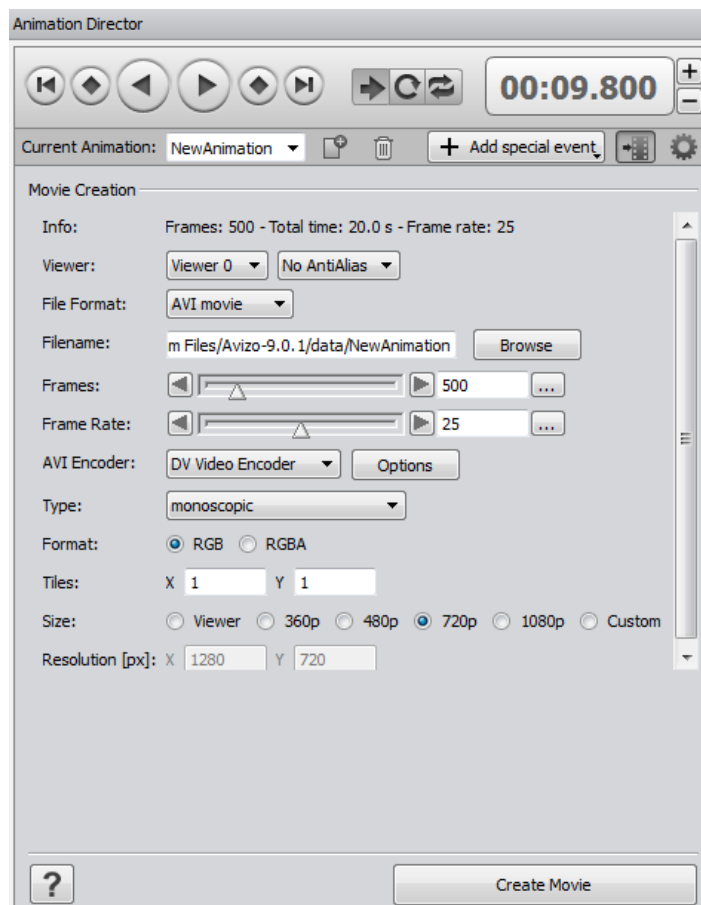

Figure 77 – Exporting the video